

ES1-275 R 4C 1277 4  
RICHARD B FONES JR  
25 BALTIMORE-ANNAPOLIS  
BLVD-FERNDALE  
GLEN BURNIE MD 21061

May, 1975 □ 75 cents

# Electronic Servicing



A HOWARD W. SAMS PUBLICATION

## PLANNING small MATV



Direct-coupled  
Audio outputs

---

Clues from the  
Big Scope

---

Modular color,  
Part 4

# PTS ELECTRONICS

**HOME OFFICE—INDIANA:**  
5233 S HWY 37  
BLOOMINGTON, INDIANA 47401  
TEL 812. 824.9331

**ALABAMA:**  
524 32ND ST. SOUTH  
BIRMINGHAM, ALA. 35222  
TEL. 205. 323-2647

**ARIZONA:**  
2412 W INDIAN SCHOOL RD.  
PHOENIX, ARZ. 85061  
TEL. 602. 279-8718

**CALIFORNIA—NORTH:**  
4611 AUBURN BLVD  
SACRAMENTO, CALIF. 95841  
TEL. 916. 482-6220

**CALIFORNIA—SOUTH:**  
5111 UNIVERSITY AVE  
SAN DIEGO, CALIF. 92105  
TEL. 714. 280-7070

**COLORADO:**  
4958 ALLISON ST.  
ARVADA, COLO. 80001  
TEL. 303. 423-7080

**FLORIDA—NORTH:**  
12934 N.W. 7TH AVE.  
MIAMI, FLA. 33168  
TEL. 305. 685-9811

**FLORIDA—SOUTH:**  
1918 BLANDING BLVD  
JACKSONVILLE, FLA. 32210  
TEL. 904. 389-9952

**INDIANA:**  
5233 S. HWY. 37  
BLOOMINGTON, IND. 47401  
TEL. 812. 824-9331

**KANSAS:**  
3116 MERRIAM LANE  
KANSAS CITY, KANSAS 66100  
TEL. 913. 831-1222

**LOUISIANA:**  
2914 WYCHWOOD DRIVE  
METAJAIRE, LOUISIANA 70033  
TEL. 504. 885-2349

**MARYLAND:**  
1105 SPRING ST.  
SILVER SPRING, MD. 20910  
TEL. 301. 565-0025

**MASSACHUSETTS:**  
191 CHESTNUT ST  
SPRINGFIELD, MASS. 01103  
TEL. 413. 734-2737

**MICHIGAN:**  
13709 W. EIGHT MILE RD  
DETROIT, MICH. 48235  
TEL. 313. 862-1783

**MINNESOTA:**  
815 W. LAKE ST.  
MINNEAPOLIS, MINN. 55408  
TEL. 612. 824-2333

**MISSOURI:**  
8456 PAGE BLVD  
ST. LOUIS, MO. 63130

**NEW YORK:**  
593 SYCAMORE ST.  
BUFFALO, N.Y. 14212  
TEL. 716. 891-4935

**NEW YORK CITY—NEW JERSEY:**  
158 MARKET ST.  
E. PATERSON, N.J. 07407  
TEL. 201. 791-6380

**NORTH CAROLINA:**  
724 SIEGLE AVE.  
CHARLOTTE, N.C. 28205  
TEL. 704. 332-8007

**OHIO:**  
5682 STATE RD  
CLEVELAND, OHIO 44134  
TEL. 216. 845-4480

**OKLAHOMA:**  
3007 N. MAY  
OKLAHOMA CITY, OKLA. 73106  
TEL. 405. 947-2013

**OREGON:**  
5220 AVE. SANDY BLVD.  
PORTLAND, OREGON 97213  
TEL. 503. 282-9636

**PENNSYLVANIA—EAST:**  
1742-44 STATE RD  
UPPER MERY, PA. 15202  
TEL. 215. 352-6609

**PENNSYLVANIA—WEST:**  
257 RIVERVIEW AVE. W.  
PITTSBURGH, PA. 15202  
TEL. 412. 761-7648

**TENNESSEE:**  
3614 LAMAR AVE  
MEMPHIS, TENN. 38118  
TEL. 901. 365-1918

**TEXAS—NORTH:**  
MOPAC LANE  
LONGVIEW, TEX. 75601  
TEL. 214. 753-4334

**TEXAS—EAST:**  
4324-26 TELEPHONE RD.  
HOUSTON, TEX. 77032  
TEL. 713. 644-6793

**WISCONSIN:**  
3509 W. NATIONAL  
MILWAUKEE, WI. 53215  
TEL. 414. 643-8800

**WASHINGTON:**  
432 Yale Avenue N.  
Seattle, WASH. 98101  
TEL. 206.623-2320

Precision Tuner Service  
is proud to announce the **GRAND OPENING**  
of our new Service Centers in



**MILWAUKEE**

**PHOENIX**

**SEATTLE**

*now you too get...*

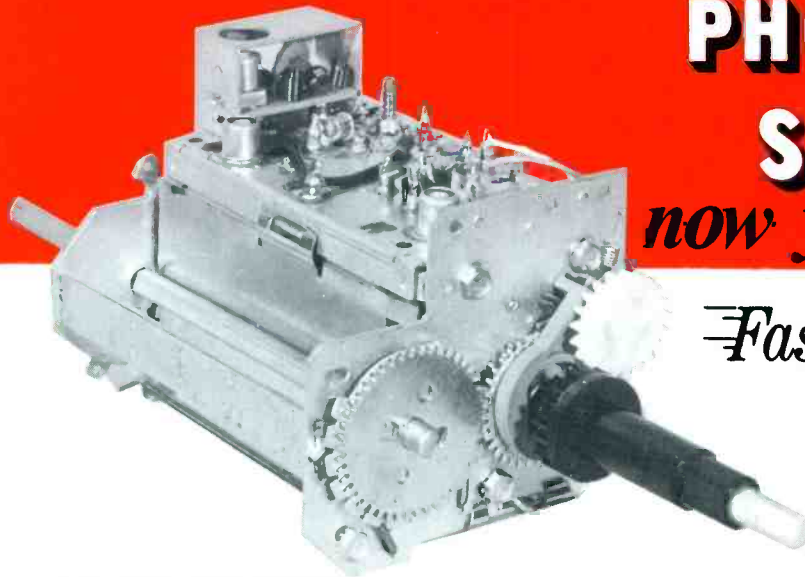

*Fast* **8** hr. Service!

**\$10<sup>95</sup>**

**1 YEAR GUARANTEE**

ALL PTS BRANCHES are wholly owned subsidiaries of PTS ELECTRONICS, INC. (NO FRANCHISES!) and report directly to the Home Office in Bloomington, Indiana. Only this way can we guarantee the same quality - PRECISION TUNER SERVICE - that made PTS the leader in this field.

New 4th edition of our **TUNER REPLACEMENT PARTS CATALOG** now available (over 100 pages of tuner blow-ups, tuner - antenna coil - and shaft replacement guides 4th edition available for \$2.00)

**WE OFFER MORE.  
SERVICE IS EVERYTHING  
WITH US.  
WE ARE DYNAMIC AND FAST.  
TRUSTWORTHY.  
YOU AND US - A  
TRUE PARTNERSHIP.**

Color •Black & White •Transistor  
•Tubes •Varactor •Detent UHF  
All Makes

VHF, UHF **\$10.95**  
UV-COMBO **\$17.95**  
IF-SUBCHASSIS **12.50**

Major parts and shipping  
charged at cost.  
(Dealer net!)  
over 4000 exact tuner replace-  
ments available for \$14.95 up  
(new or rebuilt)

*PTS ELECTRONICS, INC. is recommended by more TV  
manufacturers and overhauls more tuners than all  
other tuner services combined!*

**PTS-NUMBER ONE** AND STILL TRYING HARDER!

(NOT A FRANCHISE COMPANY)  
For More Details Circle (1) on Reply Card

# Look for the PTC Semiconductor Mart at your Mallory Distributor's.

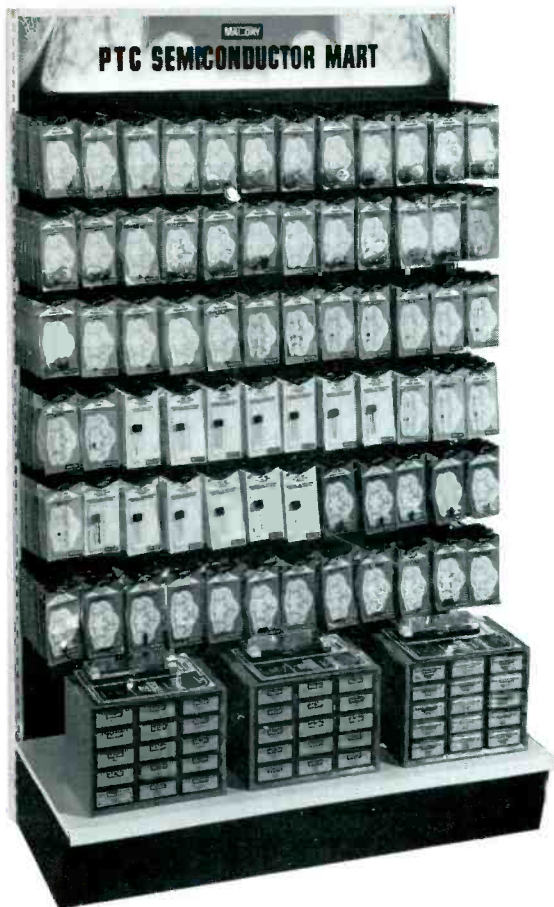

**THE SEMICONDUCTOR MART.** Here's the quick, easy way to get the replacements you need. It's the best assortment of the hottest semiconductors around. Transistors, diodes, multiple diode packages, zener diodes and integrated circuits included.

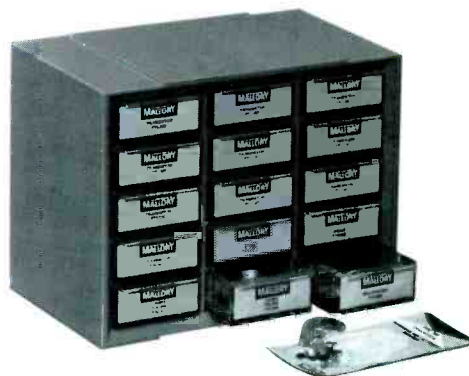

**THE FAMOUS MALLOBIN® WAREHOUSE.**  
With the semiconductors most needed by service technicians.



**FREE** copies of the very latest cross-referenced Semiconductor Product Guide.

Clear, concise product data on the packages makes your choice easy. And Mallory quality, versatility, and dependability make every choice a good one.

## You know what you need. Now you know where to find it.

**MALLORY**

**MALLORY DISTRIBUTOR PRODUCTS COMPANY**

a division of P. R. MALLORY & CO. INC.  
Box 1284, Indianapolis, Indiana 46206; Telephone: 317-856-3731

Batteries • Capacitors • Controls • Security Products • DURATAPE® • Resistors • Semiconductor • SONALERT® • Switches • Timing Devices and Motors  
MALLOBIN® is a registered trademark of P. R. Mallory & Co. Inc.

For More Details Circle (4) on Reply Card

# electronicscamer

news of the industry

---

Developers of a new home-entertainment product, the video disc player, have set up demonstrations of their systems to stir manufacturer interest. At present, the only companies who have developed systems are RCA, and N.V. Philips-MCA Inc. Referred to as the optical system, the Philips-MCA unit uses a low-power laser beam to record video on a master disc, pick up the recorded signals on a mass-produced disc, and play them back through a TV set. According to **The Wall Street Journal**, there is no physical wear because only the beam touches the flexible disc. The proposed \$500 system can run in variable slow motion, and at high speed in forward and reverse. The RCA system uses a stylus like a phonograph needle to follow a spiral groove in the disc, and picks up signals by sensing variation in electrical capacitance between the tip and the metallic coating on the disc, so wear is said to be limited. RCA says the disc playing life is about 500 hours, with life of the sapphire stylus from 300-500 hours. The \$400 machine has a pause control, but according to **Home Furnishings Daily**, RCA says the system is less suitable for stop action and slow motion effects.

General Electric has introduced a 19-inch color TV model with a 90-day labor warranty, and will reduce to 90-days its labor warranty on all 1976 color sets, according to **Home Furnishings Daily**. Monochrome sets to be introduced in June will have a 90-day parts and labor warranty.

Two more TV manufacturers have been asked by the FDA to recall color sets which could emit potentially-hazardous radiation. The **Kansas City Star** reports Quasar is in the process of recalling 2,000 of its 19-inch portable models because voltage regulation controls were not locked after factory adjustment of the sets. About 2,500 Toshiba 19-inch models might have an inadequate number of capacitors to regulate voltage, creating a potential hazard if the remaining capacitors failed, reports the FDA.

RCA Corporation plans to introduce a premium-priced line of 25-inch color TV sets this month, reports **Home Furnishings Daily**. Said to be equipped with a new, innovative chassis, the line will be available for delivery in the fall.

In the tiny Tonga kingdom in the South Pacific, Peace Corps volunteer William P. Bowden is using his skills as a radio repair technician to keep Tonga's communications equipment in good repair. Radio and telegraph systems often are the only means of communication between the 45 inhabited islands. A native of Sherman Oaks, California, and former technician with the RCA Corporation, Bowden is training Tongan apprentices to take over his work before ending his two-year service with the Peace Corps.

(Continued on page 6)

# TUNER SERVICE CORPORATION

**SUBSTITUNER**



INTRODUCING  
AT JUST

**\$39.95**  
U.S.A. ONLY

WITH CABLES

ONE YEAR  
GUARANTEE



STILL ONLY

**\$9.95**  
U.S.A. ONLY

ALL PARTS  
INCLUDED

EXCEPT TUBES  
AND TRANSISTORS

## FEATURES

- A UHF Tuner with 70 channels which are detented and indicated just like VHF channels.
- A VHF Hi Gain Solid State Tuner.
- AC Powered
- 90 Day Warranty

Demonstrate the **SUBSTITUNER** to your customers and show improved reception with their TV sets.

You may place your order through any of the Centers listed below.

PROVIDES YOU WITH A COMPLETE SERVICE FOR ALL YOUR TELEVISION TUNER REQUIREMENTS.

## REPAIR

VHF OR UHF ANY TYPE ..... (U.S.A. ONLY) \$ 9.95  
UHF/VHF COMBINATION ..... (U.S.A. ONLY) \$15.00

- IN THIS PRICE ALL PARTS ARE INCLUDED. Tubes, transistors, diodes, and nuvistors are charged extra. This price does not include mutilated tuners.
- Fast, efficient service at our conveniently located Service Centers.
- All tuners are ultrasonically cleaned, repaired, realigned, and air tested.

## REPLACE

UNIVERSAL REPLACEMENT TUNER \$12.95 (U.S.A. only)

- This price buys you a complete new tuner built specifically by Sarkes Tarzian Inc. for this purpose.
- All shafts have a maximum length of 10½" which can be cut to 1½".
- Specify heater type parallel and series 450 mA. or 600 mA.

## CUSTOMIZE

- Customized tuners are available at a cost of only \$15.95. With trade-in \$13.95. (U.S.A. only)
- Send in your original tuner for comparison purposes to any of the Centers listed below.

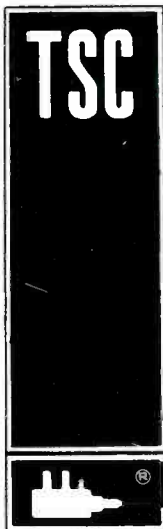

WATCH US  
GROW

HEADQUARTERS	BLOOMINGTON, INDIANA 47401	537 South Walnut Street	Tel. 812-334-0411
ARIZONA	TUCSON, ARIZONA 85713	P.O. Box 4534, 1528 S. 6th Ave.	Tel. 602-791-9243
CALIFORNIA	NORTH HOLLYWOOD, CALIF. 91601	10654 Magnolia Boulevard	Tel. 215-769-2720
	BURLINGAME, CALIF. 94010	1324 Marsten Road	Tel. 415-347-5728
	MORENO VALLEY, CALIF. 92551	123 Phoenix Avenue	Tel. 209-521-8051
FLORIDA	TAMPA, FLORIDA 33606	1505 Cypress Street	Tel. 813-283-0324
	FT. LAUDERDALE, FLORIDA 33315	104 S.W. 23rd St., Bay 11	Tel. 305-524-0914
GEORGIA	ATLANTA, GEORGIA 30310	938 Gordon Street S.W.	Tel. 404-758-2232
ILLINOIS	CHAMPAIGN, ILLINOIS 61820	405 East University Street	Tel. 217-356-6400
	CHICAGO, ILLINOIS 60621	737 West 55th Street	Tel. 312-873-5556-7
	SKOKIE, ILLINOIS 60076	5110 West Brown Street	Tel. 312-675-0230
INDIANA	HAMMOND, INDIANA 46323	6833 Grand Avenue	Tel. 219-845-2676
	INDIANAPOLIS, INDIANA 46204	112 West St. Clair Street	Tel. 317-632-3493
IOWA	WEST DES MOINES, IOWA 50265	822 Tenth Street	Tel. 515-277-0155
KENTUCKY	LOUISVILLE, KENTUCKY 40208	2920 Taylor Boulevard	Tel. 602-634-3334
LOUISIANA	SHREVEPORT, LOUISIANA 71104	3025 Highland Avenue	Tel. 318-221-3027
MARYLAND	BALTIMORE, MARYLAND 21215	5505 Reisterstown Rd., Box 2624	Tel. 301-358-1186
NEVADA	ST. LOUIS, MISSOURI 63132	10530 Page Avenue	Tel. 314-429-0633
NEW JERSEY	LAS VEGAS, NEVADA 89102	1412 Western Avenue No.	Tel. 702-384-4235
	TRENTON, NEW JERSEY 08638	901 North Olden Avenue	Tel. 609-393-0999
	JERSEY CITY, NEW JERSEY 07307	547-49 Tonhalle Ave., Hwy. 1 & 9	Tel. 201-792-3730
OHIO	CINCINNATI, OHIO 45216	7450 Vine Street	Tel. 513-821-5080
	CLEVELAND, OHIO 44109	4525 Pearl Road	Tel. 216-741-2314
OREGON	PORTLAND, OREGON 97210	1732 N.W. 25th Avenue	Tel. 503-222-9059
TENNESSEE	GREENEVILLE, TENNESSEE 37743	1215 Snapper Ferry Road	Tel. 615-639-8451
	MEMPHIS, TENNESSEE 38111	3158 Barron Avenue	Tel. 901-458-2355
TEXAS	DALLAS, TEXAS 75218	11540 Garland Road	Tel. 214-327-8413
VIRGINIA	NORFOLK, VIRGINIA 23513	3295 Santos Street	Tel. 804-855-2518
WISCONSIN	MILWAUKEE, WISCONSIN 53216	4722 W. Fond Du Lac Ave.	Tel. 414-871-7655
CANADA	ST. LAURENT, QUEBEC H4N-2L7	305 Decarie Boulevard	Tel. 514-748-8803
	CALGARY, ALBERTA T2H-0L1	448 42nd Avenue S.E.	Tel. 403-243-0971
		P.O. Box 5823, Stn. "A"	

IF YOU WANT TO BRANCH OUT INTO THE TV TUNER REPAIR BUSINESS, WRITE TO THE BLOOMINGTON HEADQUARTERS ABOUT A FRANCHISE.

For More Details Circle (5) on Reply Card

(Continued from page 4)

**As a result of New York City changing its parking rates** from 10 cents an hour to 25 cents a half hour, the price of TV and appliance repairs at home will "skyrocket", reports **Home Furnishings Daily**. In a letter to the commissioner of New York City, Department of Consumer Affairs, a service dealer complained the increased rates will make the technician more vulnerable to the possibility of his truck being towed away or being subjected to a \$25 parking fine. The dealer wrote, "How can a technician check any appliance, conform to your laws on written estimates and do a competent repair within 30 minutes?"

**Zenith Radio Corporation will introduce a new 90-day warranty** for its 1976 all-solid-state color TV sets, according to **Radio & Television Weekly**. The warranty plan will provide one-year coverage on replacement parts and two years on the color picture tube.

**Service Shop, the new NESDA-ISCET national magazine, will be published** monthly for its members. The magazine has a 7500-shop mailing list.

**To make a fair profit, service shops have to increase prices significantly**, Jesse B. Leach Jr., service dealer from Linthicum, Maryland, told those attending the NARDA School of Service Management in Philadelphia recently. Leach said he requires advance deposits for repairs, charges for estimating work, and has eliminated all warranty work except for 2 brands. According to **Home Furnishings Daily**, national surveys have shown that when service shops increased prices, they lost less than 1% of old business and eliminated less desirable customers.

**GTE Sylvania is delivering a computerized instruction system** to the U.S. Army Signal School in Fort Gordon, Georgia to help assist in the training of technical-support specialists. The equipment helps teach military personnel to repair and maintain field radios, teletypewriters, and aviation electronics communications systems.

**NARDA is considering establishing a "test" retailer-owned appliance TV chain**, **Home Furnishings Daily** reports. NARDA directors decided a retail outlet would provide the best method for measuring the efficiency of all NARDA programs, services, and know-how available from the association.

**Earl Muntz, who left the Muntz Corporation this year**, has developed a \$1,995 projection-television system with a 1200-square-inch rectangular viewing screen. **Home Furnishings Daily** reports that Muntz-Elman Manufacturing will produce the TV system. □

**Affordable frequency counter for jobs that have always needed one**

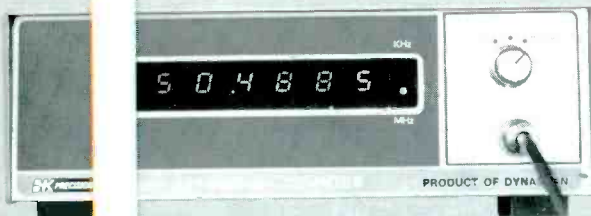

**MODEL 1801 \$230**

With a gate time autoranging frequency counter you can watch oscillator adjustments, monitor RF and audio frequencies precisely, do fast production testing, check critical signal chains, calibrate signal generators, check accuracy of AFT circuits and CB frequencies accurately. The 1801 is good because its accuracy is typically better than 10PPM; it typically reads 10Hz-60MHz and is guaranteed to read 20Hz-40MHz. It's automatic—just one control and gate times, decimal point and calibrations are automatically selected for best speed and accuracy. And it's fast—the display is refreshed 5 times per second.

In stock at your distributor.



**PRECISION**

PRODUCTS OF DYNASCAN  
1801 W. Belle Plaine Avenue Chicago, IL 60613

For More Details Circle (6) on Reply Card

## Portable Digital Multimeter at an Analog Price

**MODEL 280  
\$99<sup>95</sup>**



Enjoy the benefits of auto-polarity digital read-out plus full overload protection and high-low power ohms for accurate tests in solid-state circuits.

**Accuracy better than analog VOM's!**

### 22 RANGES

Reads in decades: AC and DC volts and mA, 1-1000; ohms, 100-10 meg. Resolution: 1mV, 1mA, 0.1ohm.

Accuracy: DC typically  $\pm 1\%$  F.S.; AC and ohms typically  $\pm 2\%$  F.S. except  $\pm 2.5\%$  on highest range. Uses "C" cells. Optional AC adapter/charger.

**In stock at your local distributor**



**PRECISION**

PRODUCTS OF DYNASCAN  
1801 W. Belle Plaine Avenue Chicago, IL 60613

For More Details Circle (7) on Reply Card



**MODEL 1248 \$175**

## If only you could take your TV Analyst with you...

... you could check a customer's set stage-by-stage in his home to find the problem. But although the TV Analyst, with its stage-by-stage signal substitution, is the single most useful diagnostic tool ever developed for TV service, it is a heavy bench instrument. And until now, about all you could take with you on a service call was a small color generator. Great for finding out that there's a problem, but no good for telling you where it is.

Until now. The 1248 is a rock-steady nine-pattern color generator with diagnostic capabilities that weighs only 4 pounds and is just 2.25" high, 7" wide and 9.38" deep. That's not bad, but that's not all.

The 1248 has IF, video, horizontal and vertical sync and sound outputs as well as the standard RF. So you can use fast signal substitution to track down dead IF stages, check the mixer, RF and local oscillators, video, sync and color stages—on a routine service call! You can use it for field diagnosis of problems in CCTV and videotape systems as well. The only instrument that can tell you more is the Analyst itself.

The 1248 has crystal-controlled RF and IF outputs; patterns are digitally generated. Put it all together and it adds up the closest you can get to a portable Analyst. **In stock at your local distributor.**

**BK PRECISION**

PRODUCTS OF DYNASCAN

1801 W. Belle Plaine Avenue Chicago, IL 60613

For More Details Circle (8) on Reply Card

**Chassis—RCA CTC53**  
**PHOTOFACT—1201-1**

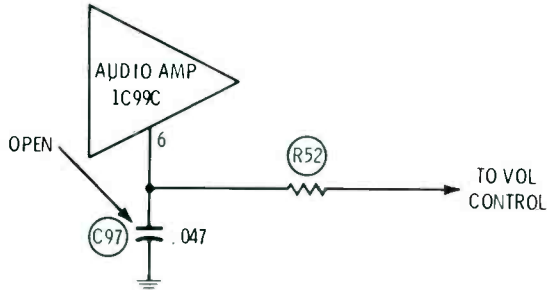

**Symptom—**No sound, or intermittent sound  
**Cure—**Check C97 on PW200, and replace if it is open

**Chassis—Zenith 20Y1C48**  
**PHOTOFACT—981-2**

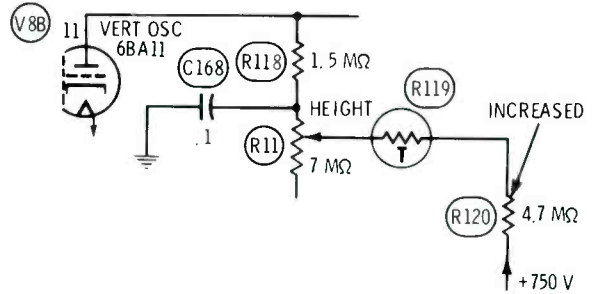

**Symptom—**Insufficient height  
**Cure—**Check R120, and replace if it is increased in value

**Chassis—Philco-Ford 2CY80**  
**PHOTOFACT—1297-1**

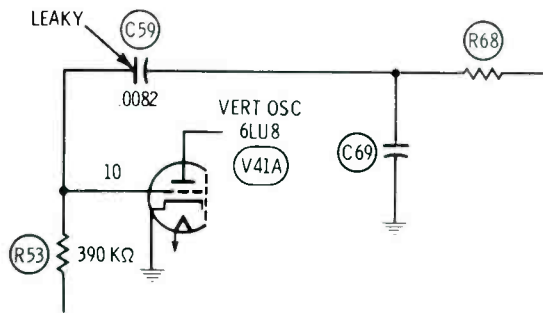

**Symptom—**Vertical roll, hold control ineffective  
**Cure—**Check C59, and replace if it is leaky

**Chassis—Philco-Ford 2CY80**  
**PHOTOFACT—1297-1**

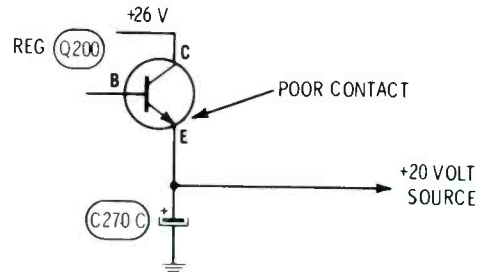

**Symptom—**No picture or sound  
**Cure—**If 20-volt supply is very low, check for poor contact at the emitter of Q200

**Chassis—Sylvania D12 (also D19)**  
**PHOTOFACT—1185-2**

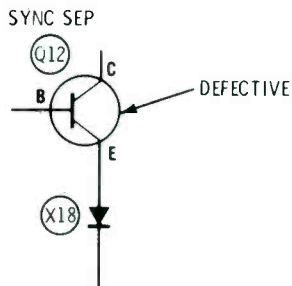

**Symptom—**Noise in picture, interference radiated to other sets  
**Cure—**Check Q12 by substitution, it might be defective

**Chassis—Sylvania D12**  
**PHOTOFACT—1185-2**

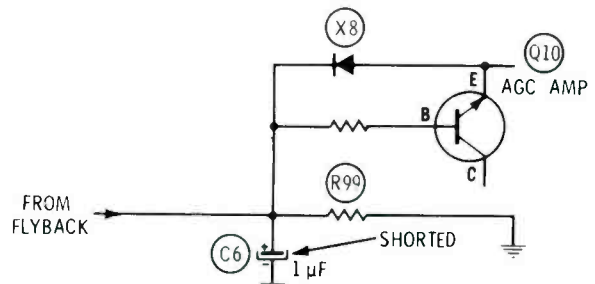

**Symptom—**AGC overload; no AGC  
**Cure—**Check C6, and replace if shorted or leaky



# reader exchange

Need a not-available service problem and to ELECTRONIC SE their offer of help di all letters sent to th

omatic? Need an obsolete part? Have an unusual help? Send information and full mailing address ING. Other ES readers should send replies with o the writer. We reserve the right to edit and print umn. **Let us help one another.**

**Needed:** Any oscilloscope m ated in Los A triggered sweep

ormation about a 21-inch screen manufactured by Electromec Incorporated. Model 1235A is a single-trace, ve, intended as an instructional aid. 's Trinity Service Center Box 9 ity Center, California 96091

**Needed:** Old r factory mater magazines pul

o manuals and text books. Original on early sets. Also need radio ved before 1940. Lawrence Beitman Tower, Room 610 409 Chalmers Champaign, Illinois 61820

**Needed:** Sche about Aul Ins 055.

tic, manual, or any information nent Company oscilloscope, Model Fris J. Piraino Bo 5 Po Summit, Pennsylvania 18346

**Needed:** Sche the Gabel M Illinois. Also r

ic for an antique jukebox made by tufacturing Company of Chicago, tubes for the amplifier, #418 JGIL. R. S. Whitmore 45 New Kent Avenue Rind, Virginia 23225

**Needed:** Sche II Model RD Novatech.

ic and service information for Pilot 04, serial 82248, manufactured by W. L. Fenska 47 Palm Beach Boulevard, Lot 27 Fo Myers, Florida 33905

**Needed:** Sche Mercury in-ci

tic and operating instructions for t rectifier tester. hur J. Gillman 2 Basil Drive Louis, Missouri 63125

**Needed:** Updc tester.

roll chart for Knight KG-600B tube id Fenton 106 nilla, Indiana 46150

**Needed:** Sche scope Model

tic and manual for Precise oscillo- C. s Unit TV Shop te 3 ntsville, Texas 77340

# ROHN® TOWERS

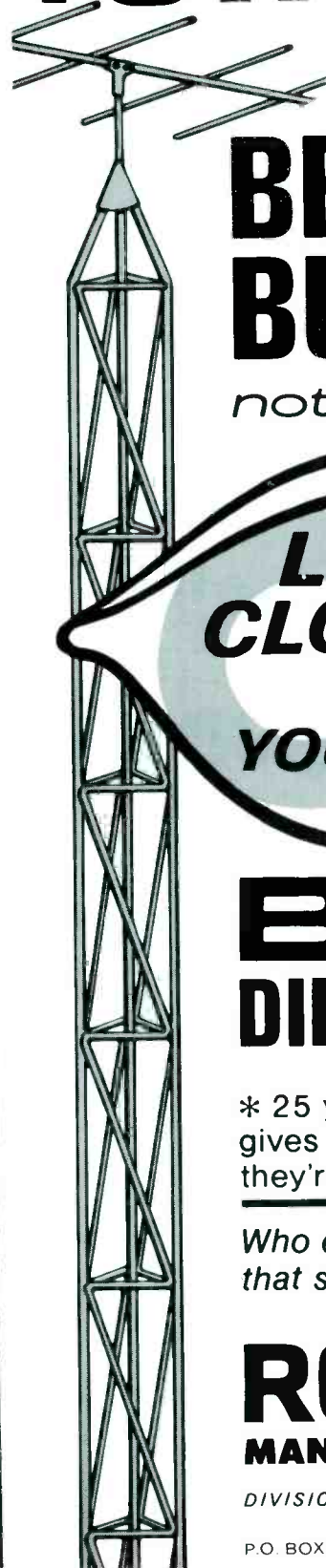

are

## BETTER BUILT

not cheaper

**LOOK CLOSELY**  
and  
**YOU'LL SEE**  
the

## BIG DIFFERENCE\*

\* 25 years manufacturing gives 25 reasons why they're BETTER!

Who else can make that statement?

## ROHN® MANUFACTURING

DIVISION OF



P.O. BOX 2000 / PEORIA, ILL. 61601

For More Details Circle (9) on Reply Card

**Needed:** Good used test equipment for 2-way FM communications radio.

John G. Sepello  
6694 N. Manlius Road  
Kirkville, New York 13082

**Needed:** Manual tuner, part number 78B6309, for Model TR-7270 Automatic radio.

Donald Lewis  
Route 1  
Central City, Nebraska 68826

**Needed:** Hood and antenna for Philco Model H-2010, or a complete set.

Roy Wikman  
5747 S. E. Ogden  
Portland, Oregon 97206

**Needed:** Schematic and operating instructions for McMurdo Silver signal generator, Model 906. Will copy and return.

Charles W. Osburn  
Schoeller Technical Papers  
Box 250  
Pulaski, New York 13142

**Needed:** Copy of "Mathematics for Electricians and Radiomen" by Nelson Cookes. Must be in good condition.

Irv Goodman  
516 S. Kenmore Avenue  
Los Angeles, California 90005

**For Sale:** All cabinet and chassis parts from a Grundig stereo, Model Locarno 3/U.

Robert P. Sweed  
630 Saul Drive  
Hubbard, Ohio 44425

**For Sale or Trade:** Heathkit 0-400 volt regulated HV supply. Will accept the best offer, or will trade for anything electronic.

Robert A. Birkholz  
Route 2 Box 10  
Terry, Montana 59349

**Needed:** Schematic for Loewe-Opta radio, type 06770W, manufactured in West Germany.

John R. Olszewski  
6047 Bonanza Drive  
Stevensville, Michigan 49127

**Needed:** Schematic and assembly instructions for EMC Model 300 tube tester manufactured by Electronics Measurement Company.

Kubin's Security Services  
OS 545 Madison Street  
Winfield, Illinois 60190

**Needed:** Schematic and service information for Majestic Model 320 radio manufactured by Grigsby-Grunow. Will copy and return, or buy.

Raymond Friend  
236 West Pearl Street  
Butler, Pennsylvania 16001

# New generation // Flat rate pricing...

...truly outdates old methods ... prices your work realistically!

Still using the old single flat rate charge for house calls or bench work regardless of repair time required? You may say it all averages out. But, how strongly do your customers feel about consumerism and TV exposés? You could be leaving yourself wide open for trouble...big trouble!

This is where **Tech's Guide to Pricing** comes in ... the "New Generation" of flat rate pricing ... the system that breaks down each repair step or adjustment encountered. Keeps a true and proper balance between cost and work performed in the eyes of the consumer.

**Tech's Guide** is in a professional, hard-use cover, 6-ring steel binding, fast-tab design, 7 1/2x9 1/2 size fits in the tool box ... ready for immediate use. Calcula'or adjusts in seconds for any area in the U.S. ... it's the new industry standard. Relieves you of the stress and pressure of pricing responsibility! Simply fill out the coupon, include check or money order. All orders filled same day.



tv & radio  
**tech's guide  
to pricing**

**\$18<sup>00</sup>**  
per issue,  
postpaid.

(Nebr. residents add city and state sales tax)

**sperry tech inc.**  
P.O. Box 5234  
Lincoln, NE. 68505

More information please.  
 My check or money order enclosed.

NAME \_\_\_\_\_  
COMPANY \_\_\_\_\_  
ADDRESS \_\_\_\_\_  
CITY \_\_\_\_\_ STATE \_\_\_\_\_ ZIP \_\_\_\_\_

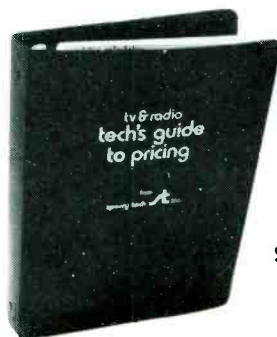

For More Details Circle (10) on Reply Card

ELECTRONIC SERVICING

**Needed:** For sound motion picture projector. Optics and reel arms must be intact.

Model 14000-AA DeVry 16-mm picture projector. Optics and reel arms in good condition and price.

Sartoris  
2 Sand Shore Road  
Wood Lake, New Jersey 07828

**Needed:** Operating and maintenance instructions for a Research Manufacturing geiger counter, Model Mojave SNB510-56.

Operating and maintenance instructions for a Research Manufacturing geiger counter, Model Mojave SNB510-56.

Bus H. Folsom  
P.O. Box 338  
Santa Ana, California 92083

**Needed:** Schematic and operating manual for Knight color/pattern generator, Model KG-685. Will buy, or copy and return.

Schematic and operating manual for Knight color/pattern generator, Model KG-685. Will buy, or copy and return.

Len Bowler  
3 Gardenia  
Lake Jackson, Texas 77566

**Needed:** Schematic and parts list for a Bigston FM/AM radio cassette tape recorder Model BR-600 made by Kyocera Electric of Japan. Will buy, or copy and return. Also need the stateside or foreign address of the manufacturer or distributor.

Schematic and parts list for a Bigston FM/AM radio cassette tape recorder Model BR-600 made by Kyocera Electric of Japan. Will buy, or copy and return. Also need the stateside or foreign address of the manufacturer or distributor.

Bob Turi  
411 Pollyanna  
Austin, Texas 78753

**Needed:** Service data for Zenith Model 1103 and General Electric Model L740 radios.

Service data for Zenith Model 1103 and General Electric Model L740 radios.

Walter McAdoo  
30 Draketown Road  
Lombard, Pennsylvania 16412

**Needed:** Schematic for Sanwa Electric Instrument Company Model K-30d.

Schematic for Sanwa Electric Instrument Company Model K-30d.

Jefford Burgess  
Agecoach Park, Box 27  
Wilhelm, Texas 76541

**Needed:** Glass radio Model 5A (about 25 years old). Will pay for any expenses.

Glass radio Model 5A (about 25 years old). Will pay for any expenses.

W. Thomalla  
11 Hillsboro Road  
Clarksville, Tennessee 37040

**Needed:** Schematic or any available information for a Candle Model AT-510A transistor television.

Schematic or any available information for a Candle Model AT-510A transistor television.

R. Krall  
31 E. Edgewood Avenue  
Rafford, Pennsylvania 15085

**Needed:** Power transformer number 54-26 for Model 10-11 Heathkit oscilloscope.

Power transformer number 54-26 for Model 10-11 Heathkit oscilloscope.

Henry Fuqua, Jr.  
423 Jordan Drive South  
Salem, Oregon 97302

**Needed:** Schematic for Colonial Model 604 receiver; also need tube receiver tubes, numbers 37, 47, 78.

Schematic for Colonial Model 604 receiver; also need tube receiver tubes, numbers 37, 47, 78.

Lanny Simon  
P.O. Box 19  
Laubstadt, Indiana 47639

# Speed TV repairs for more profits with GE's 1975 Symptom Repair Manual



The Symptom Repair Manual lists a variety of symptoms for individual GE TV chassis and tells you what to check and in what order. These symptoms and repairs were developed from thousands of service technician invoices and represent the combined experience of hundreds of technicians.

The 70-page manual is 5½" by 8½" and fits neatly in your tool caddy.

Free to subscribers of GE Technical Data, the Symptom Repair Manual is offered to every non-subscribing technician for \$1.00 handling charge (four copies—\$3.00). Effective use of the manual saves time, money and aggravation and helps to build your reputation for fast, reliable service. Send the coupon to order yours today.

"DUTCH" MEYER  
GENERAL ELECTRIC COMPANY  
COLLEGE BOULEVARD  
PORTSMOUTH, VA. 23705

PLEASE CHECK ITEMS DESIRED:

- ONE SYMPTOM REPAIR MANUAL (\$1.00 ENCLOSED)
- FOUR SYMPTOM REPAIR MANUALS (\$3.00 ENCLOSED)

ENCLOSED IS ( ) CHECK ( ) CASH OR ( ) MONEY ORDER (NO C.O.D. PLEASE)

- Please send details on GE Technical Data Subscription Plans which include all updates of the Symptom Repair Manual.

NAME \_\_\_\_\_

SERVICE COMPANY \_\_\_\_\_

ADDRESS \_\_\_\_\_

CITY \_\_\_\_\_ STATE \_\_\_\_\_ ZIP \_\_\_\_\_

We're making it our business to make your business easier.

GENERAL  ELECTRIC

# BENCH PERFORMANCE IN YOUR POCKET



The Hickok Model 239 color bar generator has an exclusive MOS LSI chip which provides 9 Rock Stable patterns and low battery drain.

- Simplified operation with 2 matrix slide switches.
- Crystal controlled chroma and timing oscillators.
- RF adjustable Channels 2-4.
- Powered by 2 standard 9v batteries.

Plus our unique 2-year warranty.

The Hickok Pocket Model 239 or our deluxe bench Model 246 are values you have to see to appreciate. See them at your Hickok distributor or contact us for more information.

**\$11500**

## HICKOK

the value innovator

INSTRUMENTATION & CONTROLS DIVISION  
THE HICKOK ELECTRICAL INSTRUMENT CO.  
10514 Dupont Avenue • Cleveland, Ohio 44108  
(216) 541-8060 • TWX: 810-421-8286

12 For More Details Circle (11) on Reply Card

## troubleshootingtips

Send in your helpful tips—we pay!

### Color on left only Sears Silvertone 529.726600 (Photofact 1091-3)

I had practically rebuilt this Sears receiver by soldering the boards, cleaning and inspecting the chassis, installing a new picture tube, and converging the three colors. It looked fine, as I gave it a last check before delivery. Raster tracking and convergence were good, but a vertical stripe about six-inches wide showed slightly lighter at the left edge of the raster.

The big surprise came when I turned up the color, and there was none, except in that same six-inch bar. In that area, the color saturation and tint both were good.

A quick scope check of the chroma signal at the demodulator showed the left 20% of the chroma to be of normal amplitude. But the remainder was missing. Voltages at demodulators and the picture tube were within tolerance.

Then I noticed the brightness and kine-bias controls were barely working. Voltage readings of the blanker showed nothing abnormal. However, there was no horizontal pulse at the blanker grid. Instead, the waveform was a sawtooth, similar to that at the grid of the horizontal-output tube.

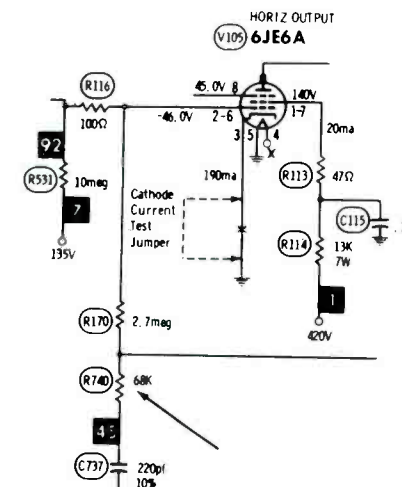

Resistance tests proved R740 (68K) was open. This eliminated the pulses from the flyback, but permitted the waveform from the

output grid to reach the blanker, thus keeping the DC voltages within tolerance.

Replacement of R740 and re-adjustment of the kine-bias control restored normal operation.

Charles E. Street  
Olympia, Washington

### Video flutter RCA CTC38 (Photofact 1000-3)

Intensity of the video would change rapidly, sometimes intermittently. It appeared somewhat like a tuner that needed neutralization, but the flutter would appear on low-band channels, so a problem of neutralization was unlikely.

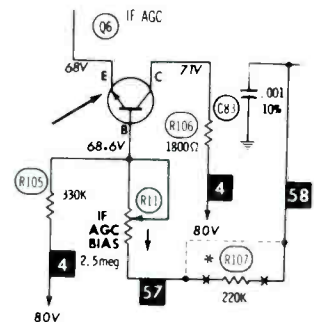

DC voltages at the base and emitter of Q6, the IF AGC transistor, changed simultaneously with the flutter. However, the emitter voltage changed more. This made me suspect the transistor, and a new transistor cured the flutter.

Mac Kellman  
Video Master TV  
Brooklyn, New York

### Intermittent arcing and picture Zenith 16Z8C50 (Photofact 1074-3)

The two symptoms were picture blackout accompanied by arcing in the picture tube. Before the set was brought to the shop, the 6LB6 horizontal-output tube had been replaced because it arced. However, the other symptoms were unchanged.

When the arcing could be heard in the yoke or picture tube, the high voltage went to zero. Discon-

nection of the picture tube replacement of

4V lead from the yoke didn't help.

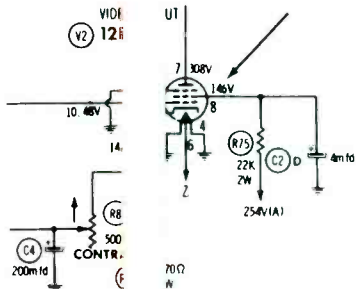

All the symptoms pointed toward a defective picture tube. However, a temporary correction externally of another picture tube showed the blackouts were continuing. That meant the tube was not the cause.

On suspicion the 12HL7 video output tube was replaced, and the arcouts were eliminated. A tube substitution showed the old 12HL7 was not the cause until it was time to be replaced. Then the tube proved to be intermittent.

Evidently the intermittent tube would reduce the CRT cathode voltage, causing excessive current, which killed the HV (causing the blackouts). Several other technicians (including the Zenith Field engineer) also thought the picture tube was the source of the problem, but I was sure it would have been an expensive and embarrassing if I had replaced it without knowing for certain.

John Stev

ms pointed toward a defective picture tube. However, a temporary correction externally of another picture tube showed the blackouts were continuing. That meant the tube was not the cause.

the 12HL7 video output tube was replaced, and the arcouts were eliminated. A tube substitution showed the old 12HL7 was not the cause until it was time to be replaced. Then the tube proved to be intermittent.

intermittent tube would reduce the CRT cathode voltage, causing excessive current, which killed the HV (causing the blackouts). Several other technicians (including the Zenith Field engineer) also thought the picture tube was the source of the problem, but I was sure it would have been an expensive and embarrassing if I had replaced it without knowing for certain.

ednansky, Bill, Montana

### Resistor burned without reason

RCA CTC24 (Photofact 9 R208 (a 6 ohm resistor connected to terminals of two filter capacitors) ran hot enough to cause the picture to black out, and the output tube glowed red because there was no drive.

The symptoms seemed to indicate

### without reason

3) ohm resistor connected to terminals of two filter capacitors ran hot enough to cause the picture to black out, and the output tube glowed red because there was no drive.

seemed to indicate

excessive drain on the 390-volt source. Only three circuits (sound detector, horiz oscillator, and horiz AFC tubes) obtain power from this point, and none showed an unusually-low resistance.

As a test, I wired in a new resistor (old one had burned in two), but added a current meter in series with one end. Normal current is about 5 mills, making the resistor dissipate only about .02 watts. Well, the meter showed about 5 mills, alright, but I was startled to see the resistor smoke and bulge as it burned.

Ordinarily, the resistor doesn't even get warm, so it seemed impossible for the resistor to burn up from the correct current. After a time of deep thinking, I concluded that AC waveforms must be overloading the resistor.

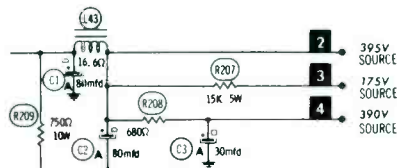

With the damper unplugged, the resistor ran cold, proving that a horizontal signal was responsible. A scope test and a capacitor substitution located the bad part; C2A was open. Some filtering was provided by C3A, but the AC current (which could not be measured by the DC meter) had overheated R208. Of course, a new filter capacitor solved the problem.

Steve Gold  
Maple Ridge  
British Columbia  
Canada

### MOVING?

Send your new address to:  
Circulation Dept.  
Electronic Servicing  
1014 Wyandotte Street  
Kansas City, Missouri  
64105

# FAST

## COMPLETE SERVICE ON ALL MAKES OF TV TUNERS

Maximum Time In Shop 24 Hrs.

(WE SHIP C.O.D.)  
YOU PAY SHIPPING  
**\$9.95**  
(Warranty: One Full Year)

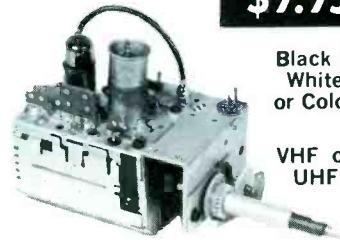

Black & White or Color

VHF or UHF

### UV Combo's \$16.50

Price includes all labor and parts except Tubes, Diodes & Transistors. If combo tuner needs only one unit repaired, disassemble and ship only defective unit. Otherwise there will be a charge for a combo tuner. When sending tuners for repair, remove mounting brackets, knobs, indicator dials, remote fine tuning arrangements and remote control drive units.

## WE UNCONDITIONALLY GUARANTEE All Tuners FOR ONE FULL YEAR



All tuners are serviced by EXPERTLY TRAINED TECHNICIANS with years of experience in this specialized field. All tuners are ALIGNED to MANUFACTURER'S SPECIFICATION on crystal controlled equipment and air checked on monitor before shipping to assure that tuner is operating properly.

## GEM CITY TUNER SERVICE

Box 6G Dabel Station  
1621 Mardon Drive  
Dayton, Ohio 45420

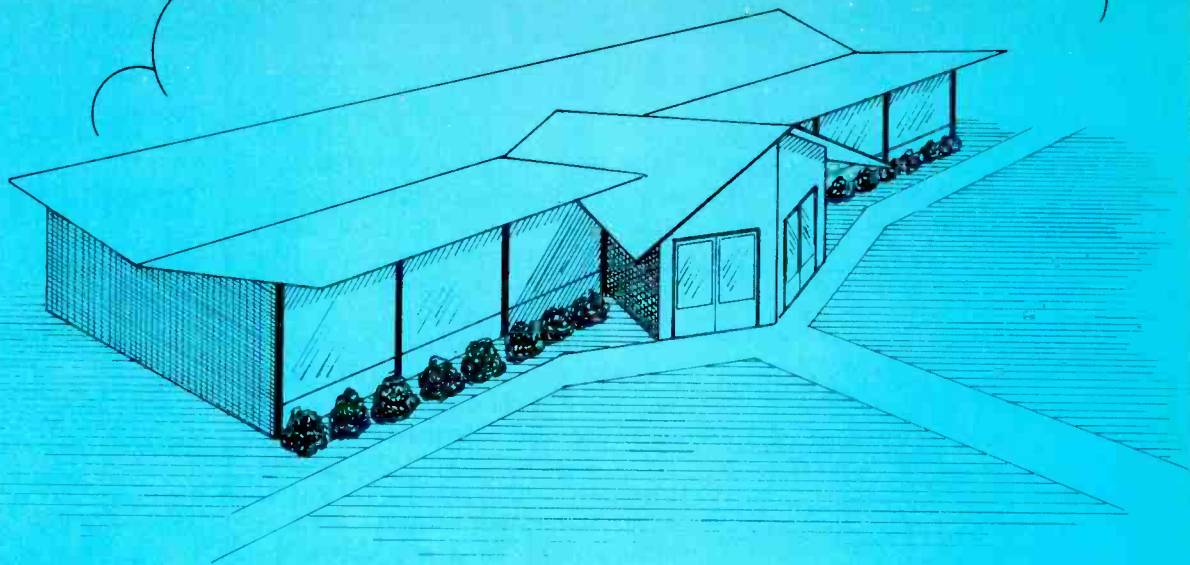

# PLANNING small MATV SYSTEMS

By Helmut Hess / Jerrold Systems Engineer

Few MATV systems are as large as those in block-square hotels or huge apartment complexes. Many require fewer than 50 TV outlets. So, if you're just starting in the MATV business, it's advisable to tackle some smaller ones before bidding on any large installations. The following suggestions should help you in planning most small MATV systems.

## Plan First

**Planning an MATV system is absolutely essential**, because there is no such thing as a **typical** TV-signal distribution system. Each and every system is unique in some way. However, a systematic approach will enable you to handle any problems that occur.

For the first step of planning, you should visit and examine the building to be wired. It makes little difference if the building is a home, church, school, apartment, hospital, office, or factory. However, the **construction** of that building, the **location**, and the **service desired** are extremely important.

## Make a check list

A check-list form, to be filled out during the visit, is very desirable. During your visit, notes should be made of the following:

### • TV channels to be distributed.

List each TV channel to be carried on the system. If FM signals are to be distributed, make a note of it. A system that carries UHF is far more costly and complicated than a VHF-only one.

### • Reception.

You must check the reception quality of each channel to be carried. Ideally, you should erect a test antenna on a collapsible tower or mast. Then measure the carrier strengths with a signal-level meter, and look at the picture on a test TV set. Alternately, there might be a TV receiver already operating at the site. Quickly observe the antenna and download to estimate the effect on the signals. Switch the receiver through all the active channels, making mental note of any receiver deficiencies that might degrade the picture

quality. Even better, use your signal-level meter and your own TV.

If none of these tests is possible, ask neighbors if their reception is acceptable, estimate distances to the TV transmitters, and notice any local conditions that might cause ghosting.

### • Number of outlets.

Find out where the TV outlets are to be placed and count the total. Mark the locations on a floor plan (Figure 1). This floor plan might be a copy of the original drawing of the building, or one you quickly sketch. In any event, include all dimensions.

### • Building construction.

Discuss with the owner or manager of the building your proposal for the antenna location, and the type of installation of the coaxial cable. Generally, the cable either can be routed through walls and closets or surface mounted. Whatever the method, make certain the owner agrees to the type of installation. Note the approximate length of coax runs required. Also, choose the locations for the head end or distribution amplifier and the antenna. If you have a choice, choose a location with easy access and even temperature for the head end.

### • Special requests.

Finally, make note of any special considerations requested by the prospective cus-

This building was chosen as the location for a theoretical small-MATV design.

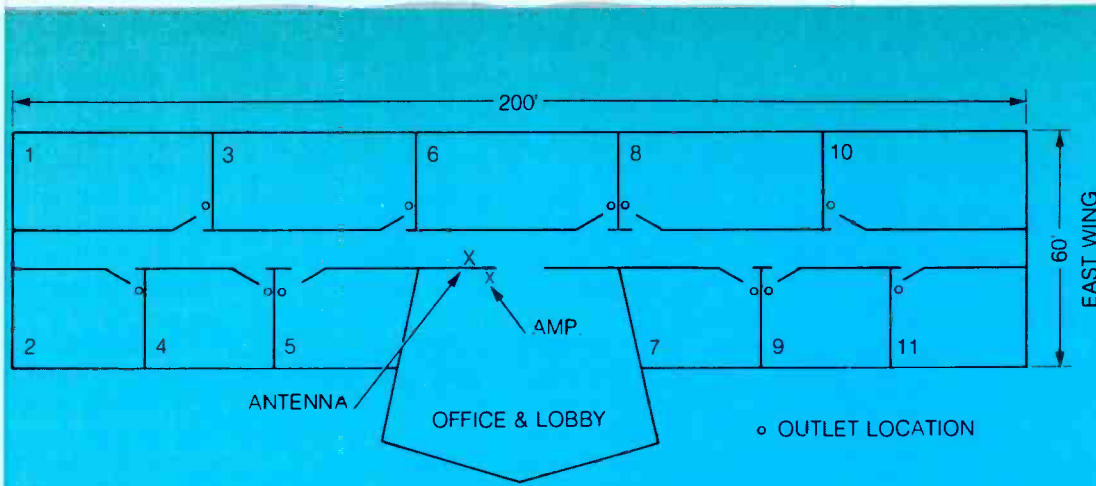

Fig. 1 On a drawing of the floor plan, mark locations of TV outlet boxes, antenna, and head-end equipment.

customer. These preferences for equipment, the other details.

This concludes the gathering essential information. Next comes the

### Tap-offs

First, choose an almost-endless variety of tap-off devices found in manufacturer's catalogs, and each basic type has its own unique application.

#### In-line tap

Indoor taps fall into two major categories. First,

might involve a particular brand of color of cable, or

the first step: gathering essential information. Planning,

### Tap-offs

kind of tap-offs. A variety can be found in manufacturer's catalogs, and each basic type has its own unique application.

#### In-line tap

fall into two major categories. First, the in-line tap

(Figure 2) designed to be installed in the feeder line. The tap is installed in the ceiling or a crawl-space, and cable is used between it and the TV outlet. In this case, the TV outlet is used only as a through connection, with the tap that's located elsewhere extracting a small amount of signal from the feeder line.

In some circumstances, in-line taps might be easier installed than other types. For example, they easily go into false ceilings of apartment buildings. Feeder lines for use with in-line taps usually are shorter, causing less signal loss. Another

advantage is that technicians do not have to enter an apartment for any checks of the system later on; the signal level can be measured at the tap in a corridor or crawl space.

#### Loop-through tap

The second type is the loop-through tap (see Figure 3). With this device, the feeder line is looped in and out through the tap. In addition to allowing the main signal to pass through with little attenuation, internal components extract the required amount of signal to supply that one TV set. It serves a double function.



Fig. 2 In-line tap installations above false ceilings.

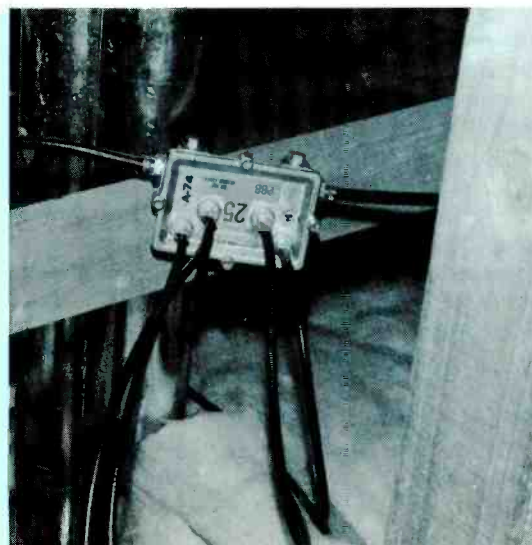

Units such as this Jerrold unit, are handy for installations above false ceilings. A cable goes to the TV box.

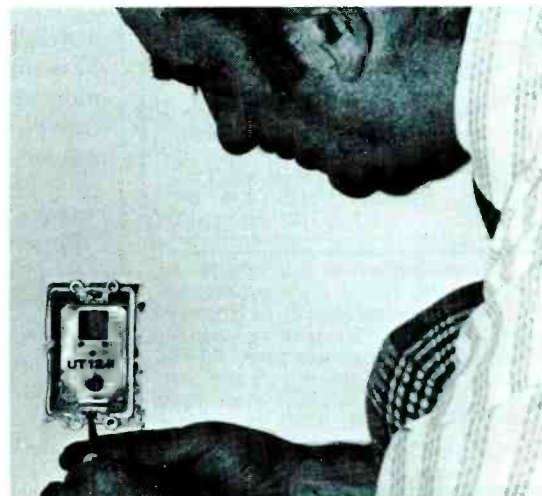

Fig. 3 Wiring is easier in some types of construction by the use of loop-through tapoffs. Each box serves both as a wiring point, and as a tapoff outlet for one TV.

# ARROW AUTOMATIC STAPLE GUNS

## CUT WIRE & CABLE INSTALLATION COSTS

... without cutting into insulation!

**SAFE!** Grooved Guide positions wire for proper staple envelopment! Grooved Driving Blade stops staple at right depth of penetration to prevent cutting into wire or cable insulation!

**No. T-18—Fits wires up to 3/16" in diameter.**

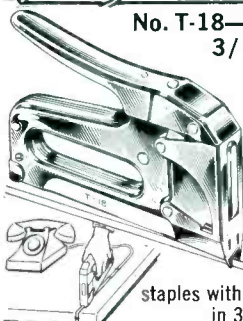

**BELL, TELEPHONE, THERMOSTAT, INTERCOM, BURGLAR ALARM and other low voltage wiring.**

Uses T-18 staples with 3/16" round crown in 3/8" leg length only.

**No. T-25—Fits wires up to 1/4" in diameter.**

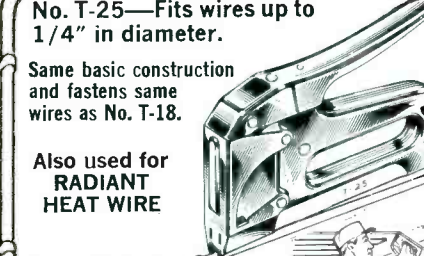

Same basic construction and fastens same wires as No. T-18.

Also used for **RADIANT HEAT WIRE**

Uses T-25 staples with 1/4" round crown in 9/32", 3/8", 7/16" and 9/16" leg lengths.

T-18 and T-25 staples also available in Monel and with beige, brown and ivory finish at extra cost.

**No. T-75—Fits wires and cables up to 1/2" in diameter.**



**RADIANT HEAT CABLE, UF CABLE, WIRE CONDUIT COPPER TUBING or any non-metallic sheathed cable.**

Also used as **DRIVE RINGS** in stringing wires.

Uses T-75 staples with 1/2" flat crown in 9/16", 5/8" and 7/8" leg lengths.

Arrow Automatic Staple Guns save 70% in time and effort on every type of wire or cable fastening job. Arrow staples are specially designed with divergent-pointed legs for easier driving and rosin-coated for greater holding power! All-steel construction and high-carbon hardened steel working parts are your assurance of maximum long-life service and trouble-free performance.

Ask your Electrical Supply Dealer or write for further details.

**ARROW FASTENER COMPANY INC**  
Saddle Brook, New Jersey 07863  
**"Pioneers and Pacesetters.  
For Almost A Half Century"**

The loop-through tap also has advantages. There are fewer units to install and wire, because the feeder line loops through each tap and doesn't require another unit for connections. The construction of some types of buildings requires this type of tap.

### Planning One System

Now, we'll plan an imaginary system requiring 11 outlets in a small nursery school, whose floor plan is shown in Figure 1.

From our first visit to the site, we know the building has a common central corridor with a false ceiling. The walls are framed in the usual way.

Multi-tap splitters above the false ceiling, and cable runs to each individual outlet work well with this kind of building construction. Therefore, we specify three four-outlet multi-taps having 14-dB isolation.

For small systems, one value of isolation is entirely adequate. The next step is to choose the type of coaxial cable. This time, we will select well-shielded RG-6 size with good foam dielectric.

### Signal level required

Before we select an amplifier for the system, we must find out how much signal is required at each television receiver, then the losses between receiver and antenna.

Many TV sets, particularly b-w models, produce excellent snow-free pictures with a signal level of 0 dBmV (1000 microvolts at 75 ohms of impedance). On the other hand, many sets tend to overload with signals above +20 dBmV (10,000 microvolts across 75 ohms). With these minimums and maximums in mind, let us pick +6 dBmV as the desired signal level for every channel.

### Losses

Between the amplifier and each receiver are losses of signal level, some planned and others that are unavoidable. Working toward the headend from Room #1, we must calculate the losses.

First, there is a length of cable between the set and the multi-tap. RG-6 foam-dielectric cable causes a loss of approximately 3 dB per hundred feet at VHF frequencies, or 6 dB at UHF. Assuming VHF only, and 30 feet of cable between

set and tap, the loss is about 1 dB.

Next is the loss in the multi-tap itself, which was chosen as 14 dB to provide sufficient isolation between the various receivers. Following that is another length of cable. From the plan, we can estimate a run of about 65 feet, or about 2 dB of signal loss.

Upstream from the multi-tap supplying room #1 is another multi-tap giving about 2 dB loss to the signal fed through it. Just a short distance away (too near to count cable loss) is the 2-way signal splitter that supplies the east and west wings. Such splitters have a nominal loss of 3 dB. Finally, there's a small loss (say 1 dB) from the cable to the amplifier.

Now, we add all the losses between Room #1 and the amplifier, and obtain 23 dB. Adding 23 dBmV to the 6 dBmV required by the TV in Room #1 gives 29 dBmV, the minimum output necessary from the headend.

### Antenna signal levels

The next step is to refer to the notes made during the first visit to the site. How much signal was available from the antenna for each desired channel? If the level of each channel was +29 dBmV, or stronger, an amplifier is not needed.

This much signal often can be found when the distance between the VHF stations and a medium-sized antenna is less than 10 miles. If an amplifier is not necessary, you are ahead of the game. Under some circumstances, amplifiers can introduce problems. For example, if the signal from one station is much stronger than the others, a broadband amplifier might overload and cause cross-modulation distortion before the weak stations were amplified enough.

A small amplifier of about 15-dB gain probably is enough for distances up to 20 miles. But for distances of more than 20 miles, a higher-gain amplifier will be required.

### Output versus gain

Don't be misled by extra-high gain. That's because the gain of an amplifier usually is secondary in importance to a parameter called "output capability". This term is equivalent to the output power of a final amplifier in a radio transmit-



**We hope  
you've  
been keeping  
tabs on us.**



Thanks to Sav-a-Tab, you really ripped us off last year. Thousands of dealers and service technicians ripped tabs off Sylvania receiving tube boxes and received thousands of valuable awards.

And we like it! That's why we're coming back with Sylvania Sav-a-Tab '75—bigger and better than ever before!

All you have to do is save the tab marked "WALTHAM" found on every Sylvania receiving tube box. By saving these tabs from now until November 30, 1975, you can redeem them for great awards. And you don't need a million of 'em to earn a prize.

Visit your local authorized Sylvania Distributor and pick up your *free* Sylvania Sav-a-Tab '75 Award Catalog, special Tab Saver Envelope, and Award Order Form with complete instructions. Or fill in the handy order form below.

Sav-a-Tab '75! It's a great way to save all around. Save time by stocking one line of tubes—Sylvania. Save money on unnecessary callbacks thanks to Sylvania quality. And save on great merchandise awards with Sylvania Sav-a-Tab '75!



**SYLVANIA  
SAV-A-TAB  
75**

# Introducing...

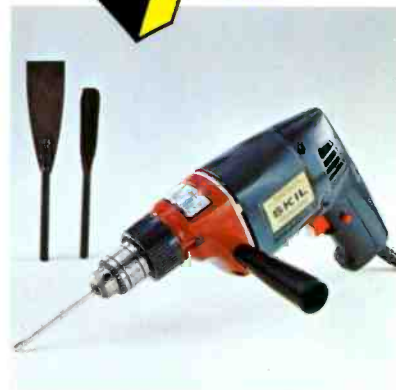

## **GTE SYLVANIA Sav-a-Tab '75**

**MAIL THIS CARD TO:  
SYLVANIA AWARD HEADQUARTERS  
P.O. Box 1000, Fenton, Missouri 63026**

NAME \_\_\_\_\_

COMPANY \_\_\_\_\_

ADDRESS \_\_\_\_\_

CITY \_\_\_\_\_

STATE \_\_\_\_\_ ZIP \_\_\_\_\_



The Sylvania Sav-a-Tab Program is available only to dealers and service technicians. Employees of General Telephone & Electronics, GTE Sylvania, their subsidiaries, affiliates, authorized franchised distributors, or their advertising agency are not eligible to participate.  
ET-1964

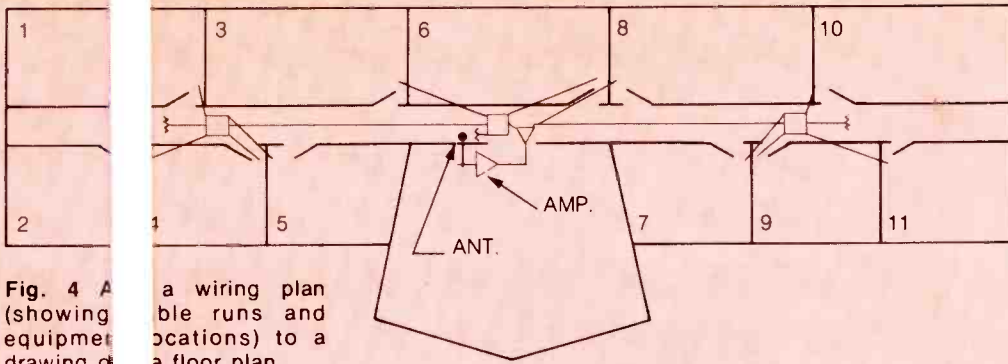

Fig. 4 A wiring plan (showing cable runs and equipment locations) to a floor plan.

ter. If such a out low power signal over long distances is impossible, regardless of the amplifier holds true for amplifiers. E capable of producing sufficient output power to losses and still signal level to line. Then t sufficient to signal level up output.

In this case have sufficient relatively-undis of +29 dBmV.

**Which antenna?**

The last step selection of an adequate signal it's not always an antenna with No antenna ever appearance of a higher gain ones ge. Also, smaller antennas have wind resistance, which minimiz maintenance and possible dam from storms. Therefore, sel an antenna of no more.

In addition good-quality consumer-type antennas, commercial-grade antennas are available. These have rugged construction, and do not require a matching transformer (as consumer-types do) because they have coax connections.

**Submit**

Make a rough sketch showing the locations of major items of equipment, as shown in Figure 4. (The electrical schematic is in

radio amplifier puts reception of its distances is impossible the internal gain of the amplifier. The same idea for MATV distribution one must be able to provide adequate gain must be the needed power output.

The amplifier must be able to provide a relatively-undis output signal of +29 dBmV.

selection of an adequate signal it's not always an antenna with No antenna ever appearance of a higher gain ones ge. Also, smaller antennas have wind resistance, which minimiz maintenance and possible dam from storms. Therefore, sel an antenna of no more.

good-quality consumer-type antennas, commercial-grade antennas are available. These have rugged construction, and do not require a matching transformer (as consumer-types do) because they have coax connections.

**g The Bid**

etch showing the locations of major items of equipment, as shown in Figure 4. (The electrical schematic is in

Figure 5.)

From this layout, prepare a bill of materials and labor, and submit them to the prospective customer. Your thoroughness undoubtedly will make a favorable impression.

**General Advice**

Before you have acquired some experience, use extra care in planning each system, including the use of a check-list.

Some of the preparatory work can be reduced when you learn the signal levels typically obtained in various sections of your area.

Consider yourself a "pro" at the MATV game when you can give an offhand statement, such as "Oh, 26 outlets in the northeast section of town should run you about XX dollars", and then back it up with a well-designed system at a firm bid price. □

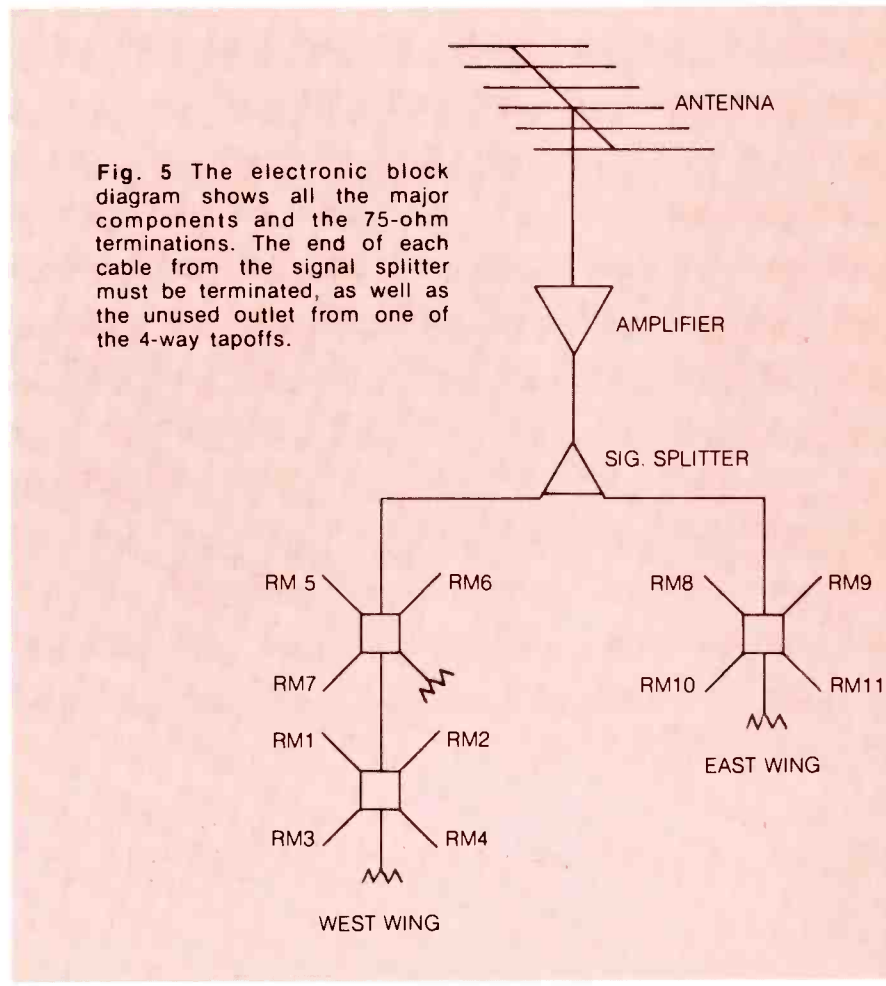

Fig. 5 The electronic block diagram shows all the major components and the 75-ohm terminations. The end of each cable from the signal splitter must be terminated, as well as the unused outlet from one of the 4-way tapoffs.

# HOW TO EXORCISE A COW

By John Rozsa

On a hot, humid summer morning, I had just completed the second TV service call and left the customer's home. Inside my station wagon, I picked up the microphone of the CB radio and called Ethel, my wife, who was minding the store. She reported one more request for a service call. "Maggie Stevens of 1048 Maple wants you to hurry there and get the cow out of her TV." "Repeat, please. I thought you said cow." "Well, that's what she said, and she even spelled it for me; C-O-W, cow."

Those remarks bothered me enough that I almost forgot to give the legal CB sign-off. Now, I have found mice and bugs in electronic equipment before, but hardly a cow. However, the paying customer is always right, and if she was that agitated it might be a good idea to go there next. The other calls could wait an extra hour.

As I headed toward Maple Street, I began singing the old song, "I'm an old cowhand, from the Rio Grande." I tried to sing, "A cow in a TV; that's a new one on me," but the words didn't fit the music.

Soon the skies darkened, the wind came in gusts, and thunder reverberated under black clouds. The rain started as a gentle sprinkle, but soon became a torrent so intense that the wipers couldn't handle the flow. I pulled over to the curbing and cut the ignition. In a few minutes, the rain slowed to a gentle mist, the wind became calm, and I resumed the trip. It had been just a brief, but violent, summer shower.

I stopped for a quick cup of coffee at my favorite doughnut shop. But the ridiculous thought of a cow in a TV kept running through my mind. Could it be a joke? Not likely, for who would pay



for a service call for that purpose? On the other hand, if it was a misunderstanding, a phone call that saved an hour and a useless trip would be cheap enough.

So, I dialed Mrs. Stevens' number from the pay phone. After I identified myself, she said, "John, please come over right away and get this cow out of my TV!" I asked why she thought her TV had a cow in it, and she explained that a loud "moo" came out of the set every once in a while, even while it was turned off. To calm her nervousness, I promised to be there in a few minutes.

After I arrived at her home, I grabbed a caddy and tube tester (momentarily wishing they were milking stool and bucket) and walked to the door.

I turned on the power to the TV, and sound and picture both appeared after the usual delay for the tubes to heat. There was nothing wrong with either the sound or picture, but after a couple of minutes a loud cow-like sound apparently came from the TV cabinet! It was a real spooky sound, totally unlike any TV defect I'd ever heard.

The customer was concerned about damage to the set, but I

recovered my professional set-side manner enough to reassure her that such danger was unlikely.

Very carefully, I eyeballed the TV cabinet and the room near it; nothing seemed unusual. I pulled the cabinet away from the wall, and had just removed the back (along with the power cable), when the sound came again. This time my stereo hearing proved the sound was coming from the wall of the house, not from the TV cabinet! Quickly, before the sound stopped, I placed my hand on the wall and felt the vibrations. Something was shaking the wall at an audio rate.

A search around the outside of the house quickly located the audible bovine. On the outside wall, just above where the TV cabinet was located, was anchored the telephone wire. And several yards from the house, a large tree branch was lying across the phone wire. Apparently, it had been partially broken by a violent thunderstorm a few days before. Anyway, when the wind blew, the tree limb vibrated the phone wire, and the wire shook the wall of the house, producing a bellowing noise, perhaps amplified by the Helmholtz effect of the air space in the wall. The way a violin makes music is similar; the bow vibrates the string, and the string shakes the body, producing sounds.

I borrowed a saw and ladder, removed the offending tree limb, and replaced the back on the TV receiver. That stopped the "moo."

"Thanks for fixing the problem," Mrs. Stevens said, "It's worth the price of a service call so we can get some sleep tonight."

After I finished the other service calls, I started back to the shop. "Put on a fresh pot of coffee, Ethel, I'm coming in. By the way, that Stevens call was just a bum-steer. I'll tell you about it later." □

# Servicing Direct-Coupled Stereo Outputs

By Bernard Kashiir, CET

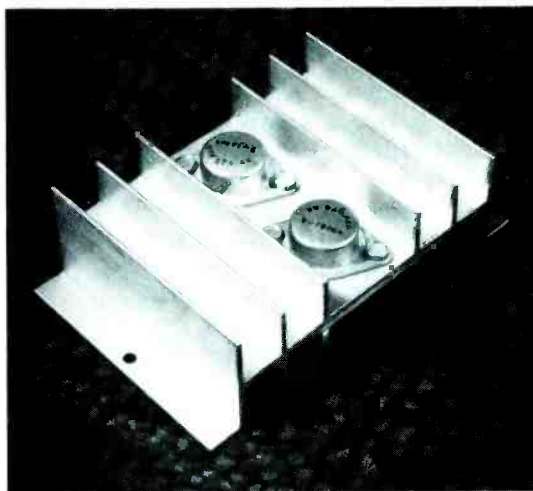

Many pitfalls await technicians who try to diagnose defects in direct-coupled audio-output stages without knowing the best methods. Here are suggestions to speed up this type of servicing.

Perhaps "direct-coupled" is too strong a term to describe the audio-output section of solid-state stereo amplifiers. However, service records do prove that failures in direct-coupled output circuits far exceed those in low-level stages.

This is not surprising since power transistors often operate at voltages, currents, and temperatures approaching their maximum values. Although transistors have no gradual weakening potential internal defects, or by other electronic components, a exposed to possible outside world.

One of the greatest headaches of solid-state servicing is to install a new part or transistor, only to have one or more transistors fail immediately when power is turned on. Transistor failure has no tolerance beyond a certain point. Severe circuit loads can blow a transistor faster than a fuse can protect it.

Therefore, the greatest needs are for accurate knowledge of how the circuits operate and fast servicing methods that permit testing without ruining additional components. We'll start with the basic theory.

## Complementary Pair

The most-simplified push-pull tra-

nsistor area" is too describe the audio-output section of solid-state stereo amplifiers. However, service records do prove that failures in direct-coupled output circuits far exceed those in low-level stages.

This is not surprising since power transistors often operate at voltages, currents, and temperatures approaching their maximum values. Although transistors have no gradual weakening potential internal defects, or by other electronic components, a exposed to possible outside world.

One of the greatest headaches of solid-state servicing is to install a new part or transistor, only to have one or more transistors fail immediately when power is turned on. Transistor failure has no tolerance beyond a certain point. Severe circuit loads can blow a transistor faster than a fuse can protect it.

Therefore, the greatest needs are for accurate knowledge of how the circuits operate and fast servicing methods that permit testing without ruining additional components. We'll start with the basic theory.

## Complementary Pair

The most-simplified push-pull tra-

stage is the complementary-symmetry type, shown in Figure 1. The transistors are identical, except that Q1 is a NPN type and Q2 is a PNP. Therefore, a change of the common base bias increases the forward bias and collector current of one transistor, and decreases the forward bias and current of the other (see the equivalent circuit in Figure 1). This gives a push-pull action.

Heavy-duty transistors have such low impedances that they can match efficiently the normal impedance of hi-fi speakers (4 to 8 ohms usually). No output transformer is necessary for impedance matching.

Two power sources (one positive for the NPN, and one negative for the PNP transistor) make possible a DC output voltage from the emitters that almost is zero. This zero voltage eliminates the need for an output transformer or a coupling capacitor.

Unfortunately, the circuit as shown is too simple to operate correctly. A common base voltage that would give the proper forward bias for Q1 would be reverse bias for Q2, and vice versa. Additional components, including a diode to give stability against temperature changes, must be added so that each transistor has the correct polarity of B/E voltage for forward bias, and that the biases produce equal collector currents. This

should make the output voltage about zero DC from the emitters.

Although the currents of the transistors have been balanced, one more important condition must be satisfied: the bias of Q1 and Q2 should be the voltage giving minimum "notch" distortion.

## Notch Distortion

It hasn't been mentioned yet, but the transistors in all circuits of this kind are operated in Class "B". That is, when the input signal is a sine wave, each transistor conducts current for one-half of the cycle. Because they are opposite in polarity, one transistor conducts during the positive-going half, and the other transistor conducts during the negative-going half. The problem arises in adding these separate half-cycles together to produce an undistorted sine wave.

Assume that we're operating the output transistors with almost no DC forward bias. Of course, the AC sine wave acts as forward bias and makes the transistors conduct alternately. Unfortunately, each conducts less than 50% of the cycle, leaving a point near the center of the sine wave without any current (see Figure 2). The result is a "notch". With the condition shown, the audible distortion would be intolerable.

At the other extreme, excessive

forward bias allows each transistor to conduct for more than 50% of each cycle, resulting in a stretching of the sine wave near the center (Figure 3). Again, this is distortion.

Figure 4 shows how optimum bias and balanced transistors can produce relatively undistorted sine waves.

Notch (transition) distortion is more noticeable at low volume levels. That's because the notches are the same size regardless of the signal amplitude; therefore, the larger the signal is, the smaller the notches are in proportion. This is just the reverse of most other kinds of distortion which gets worse as the output power is increased.

Elimination of transformers provides extended bandwidth, an important consideration where negative feedback is concerned. Disadvantages include the need for another heavy-duty power source, and the danger that excessive current from a shorted transistor might damage the speaker and some power-supply components. That's why fuses often are included; to prevent any damage except the original defect.

### Speaker-Coupling Capacitor

One popular variation of the complementary-symmetry output circuit uses a single power source and a large coupling capacitor between emitters and speaker, as shown in Figure 5.

Again, there are trade-offs. Addition of one capacitor eliminates the second power supply. The high-pass filter action reduces the low bass frequencies somewhat, but it also minimizes rumble, motorboating, or thumps of the sub-sonic range. For example, a 500 microfarad capacitor is equivalent to about a 10-ohm resistor at 30 Hz. This represents more than 6 dB of roll-off at 30 Hz.

Both transistors are in series from power supply to ground, and their average currents should be equal. Therefore, **the voltage drop across Q1 should be about the same as the drop across Q2**, an important fact for troubleshooting.

#### Where does Q2 get its power?

Without an audio signal at their bases, Q1 and Q2 have only a small collector current; they are nearly cutoff. The current and voltage for Q2 must go through Q1. When the

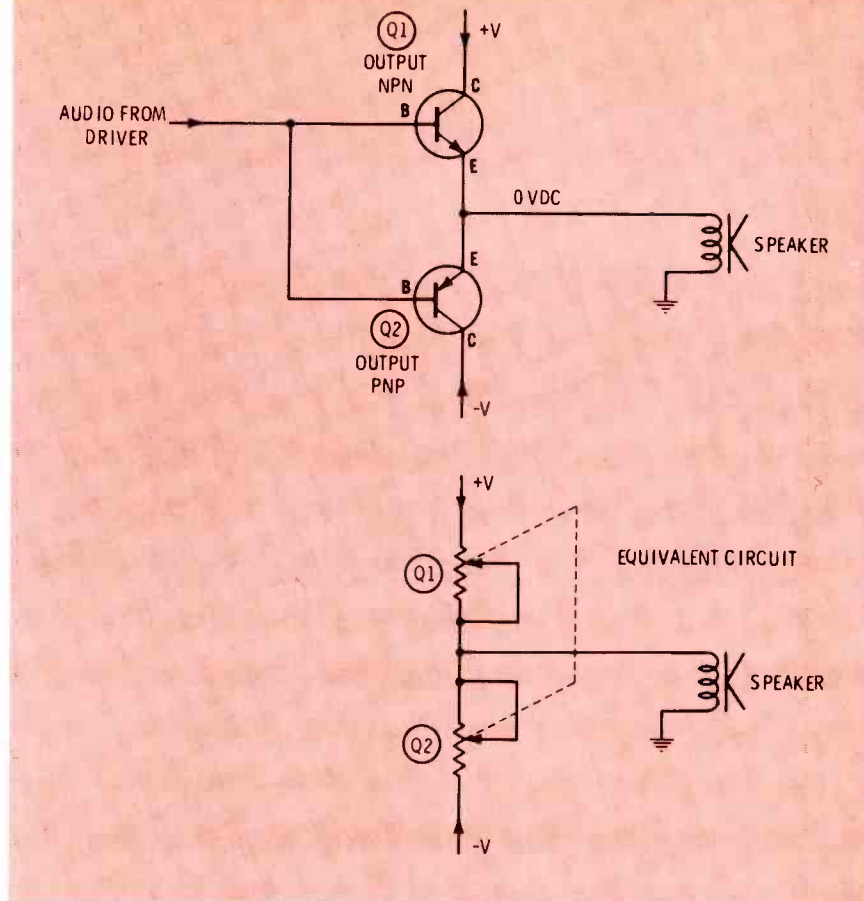

Fig. 1 Simplified complementary-symmetry transistorized audio circuit has transistors of opposite polarity, two power supplies, and direct coupling to the speaker. The circuit can be considered as a bridge (power supplies as two legs); any unbalance flows through the speaker. The emitter current of one transistor increases and the other decreases simultaneously.

base signal is negative-going, Q1 is more than cutoff, while Q2 is biased for heavy conduction. At this time, it's impossible for Q1 to supply the current needed by Q2.

The answer is that C1, the coupling capacitor between transistors and speaker, acts as a storage reservoir which is charged by Q1 and discharged by Q2 as needed. Of course, the charging and discharging currents go through the speaker to produce the audible sounds. The average DC voltage across C1 should be about one-half the supply voltage.

### Emitter Followers

Because the output signal is taken from the common emitters, this stage is classified as a "common-emitter" type. Such stages give a power gain, but a slight voltage loss. Only the previous stages have voltage gain.

If 10 volts RMS is required at the speaker, 10 volts RMS must be supplied to the bases of Q1 and Q2

(relative to ground).

### Negative Feedback

Negative feedback occurs when a sample of audio signal is fed back to a previous stage where the phase difference is 180°. Such feedback reduces distortion, widens the bandwidth, decreases the output impedance, and usually reduces the hum level. Usually, the only penalty is a loss of gain. It seems to be a bargain, and within certain limits it is.

You have heard the saying, "If some is good, much more is better". That's not true with negative feedback; there is an optimum point. Extra phase shifts which total 180° at either extreme of high or low frequencies in either amplifier or feedback paths can change the amplifier into a phase-shift oscillator, if the feedback is strong enough. The result is a full-power supersonic whistle or a sub-sonic motorboat. Either causes raspy tone quality, even when the audio level is

moderate and can't be heard. When there seems to be no cause for oscillation, suspect by parts defects.

Commercial circuits are engineered with component values tailored to roll-off the amplifier high frequencies. This gain reduction, plus moderate feedback maintain the circuit from oscillating at the original values. To do so probably will cause oscillation and excessive distortion.

For the same reason, parts defects that increase the amount of negative feedback often increase the distortion and noise level. An amplifier that is oscillating at a supersonic frequency will exhibit excessive noise and hum for none of the usual reasons. Keep this in mind if the complaint primarily concerns noise and hum.

In the complementary-symmetry amplifiers, feedback is used to cancel most of the remaining notch distortion, and to reduce the low output impedance even more.

#### A Typical Color-Brite Circuit

The circuit of a typical complementary-symmetry output stage is shown in Figure 6. First, notice the small value of the input coupling capacitor, C219. Values of several microfarads are used in many circuits to give good bass response, the large for low base impedance can be smaller if the base impedance is higher. In this case, the input impedance of Q203 has been raised by the negative feedback inserted at the emitter of Q203.

The amount of feedback is limited by R221, and C221. R221 and R222 form a voltage divider that reduces the amplitude of the feedback signal, and C221 provides an AC path to ground without shorting out the DC voltage. In other words, the three parts form a voltage divider to AC, but not to the DC. If C221 should open, the gain would decrease because of the extra feedback, and it's likely the amplifier would oscillate, causing late, causing

Collector voltage for Q203 comes from the +36V DC supply through the base-emitter junction of Q204, and the emitter circuit goes through

oscillation itself. When there seems to be no cause for oscillation, suspect by parts defects.

Commercial circuits are engineered with component values tailored to roll-off the amplifier high frequencies. This gain reduction, plus moderate feedback maintain the circuit from oscillating at the original values. To do so probably will cause oscillation and excessive distortion.

For the same reason, parts defects that increase the amount of negative feedback often increase the distortion and noise level. An amplifier that is oscillating at a supersonic frequency will exhibit excessive noise and hum for none of the usual reasons. Keep this in mind if the complaint primarily concerns noise and hum.

In the complementary-symmetry amplifiers, feedback is used to cancel most of the remaining notch distortion, and to reduce the low output impedance even more.

#### A Typical Color-Brite Circuit

The circuit of a typical complementary-symmetry output stage is shown in Figure 6. First, notice the small value of the input coupling capacitor, C219. Values of several microfarads are used in many circuits to give good bass response, the large for low base impedance can be smaller if the base impedance is higher. In this case, the input impedance of Q203 has been raised by the negative feedback inserted at the emitter of Q203.

The amount of feedback is limited by R221, and C221. R221 and R222 form a voltage divider that reduces the amplitude of the feedback signal, and C221 provides an AC path to ground without shorting out the DC voltage. In other words, the three parts form a voltage divider to AC, but not to the DC. If C221 should open, the gain would decrease because of the extra feedback, and it's likely the amplifier would oscillate, causing late, causing

Collector voltage for Q203 comes from the +36V DC supply through the base-emitter junction of Q204, and the emitter circuit goes through

R221 back to +16.5 VDC at the emitters of the output transistors.

The driver transistor, Q204, is an intermediate-power PNP that's direct coupled to the base of Q205 (the NPN output transistor), and through SD201 and R223 to the base of Q206, the PNP output transistor. R225 adds some negative forward bias to Q206. That way both output transistors have the proper amount and polarity of forward bias. In addition, R225 adds a small amount of feedback.

#### Closed Loop Circuits

In Figure 6, what appears to be one closed loop (signal going through Q203, Q204 and Q205/Q206 and back to the emitter of Q203) actually is two parallel loops, one for AC audio signals, and the other for DC voltages.

One closed loop can complicate troubleshooting, but two make the situation nearly impossible. With just a few exceptions, a defect in any part affects signal amplitude, distortion, and all DC voltages.

# Retrieve Fading Color... And Save Money, Too

## with Perma Power Color-Brite



Save \$4.65 when you buy a four-pack of Model C-511 Color-Brites. And get a magnetic telescoping retriever free!

Ever dropped a nut or screw and had it bounce away from you, out of reach? With this magnetic telescoping retriever, it's easy pickings! The 5" long retriever clips to your pocket, so it's handy whenever you need to retrieve a part as far as 19 inches away.

It's just as easy to retrieve sharpness, contrast and fading color! Install a Perma Power Color-Brite . . . for immediate TV picture improvement and certain customer satisfaction. Model C-511 is the one you need for the prevalent rectangular picture tubes. These Color Brites usually sell for \$6.15 each, but for a limited time you can get a four-pack for just \$19.95. That's a \$4.65 savings, and the retriever is our gift. But supplies are limited, so see your distributor *today*.



## Perma Power®

Chamberlain Manufacturing Corporation  
Perma Power Division  
5740 North Tripp Avenue, Chicago, Illinois 60646  
Telephone (312) 539-7171

If those changes are minor, the usual waveform and DC voltage tests are quite efficient in finding the trouble. But cases involving massive failures require a different procedure.

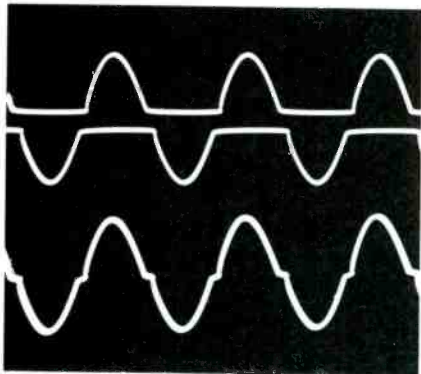

**Fig. 2** Both output transistors are operated in Class "B" so each **should** conduct for 50% of each sine wave of signal. Insufficient forward bias causes transition distortion (notches at center), because each transistor draws current for less than 50% of each cycle.

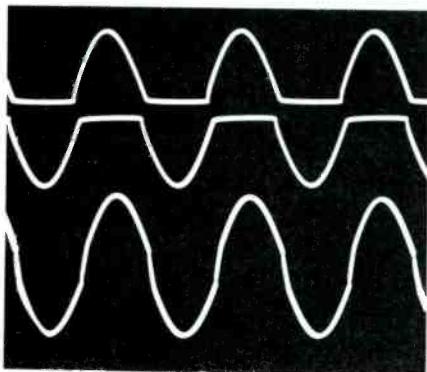

**Fig. 3** Excessive forward bias causes each transistor to conduct for more than 50% of each sine wave, producing a stretching near the center. This distortion also is objectionable.

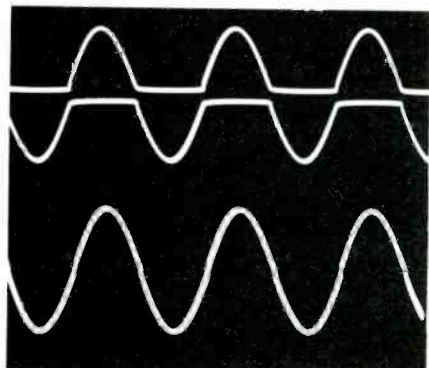

**Fig. 4** Correct forward bias permits both transistors to conduct for exactly 50% of each cycle. The remaining distortion is worse at low volume levels, and is minimum just below the clipping point.

## Testing Procedures

When an FM-stereo receiver or amplifier enters a repair shop, the usual complaint is that one channel is dead, distorted, or noisy, or that a fuse blows. First, obtain a schematic and service notes for the model (if at all possible). Even when you understand theory and are familiar with most basic circuits, it's hard to trace the wiring or identify components without the data.

But, if this information is not available, all is not lost. Usually only one of the two (or four with quadriphonic) channels is bad, and the normal channel can be used as a standard.

### Power-off tests

Here is a practical sequence of passive tests:

- Visually inspect the board for burned resistors, or other obvious abnormal conditions;
- Test all transistors of the direct-coupled chain; and
- Replace any obviously-defective parts, and transistors that test bad.

Following those preliminaries, **power-on tests using limited voltage and current should be used before full power is restored.** Before those tests, we will consider the passive tests in more detail.

Burned resistors which are not a part of the power supply, usually point to shorted output transistors. This tip can save much time. Some circuits have emitter resistors for two reasons. Not only do they help the thermal stability, but they act as protective devices, often opening when a transistor shorts.

Incidentally, replace any resistors that either are out of tolerance or show signs of having been overheated. Delayed failures sometimes occur after overloads.

Some tests of transistors can be done either in-circuit or out-of-circuit. Because of circuit loading, accuracy always is higher out-of-circuit. But in-circuit tests have great time-saving value as first, approximate evaluations.

For example, a series of ohmmeter tests (using a low range to minimize the effects of circuit loading) almost is certain to find dead shorts between collector and emitter (a common fault), and should raise questions about other

defects, which can be answered by subsequent out-of-circuit measurements. When in doubt, compare readings of one channel against the other.

Stated in the most-simple way, these are the results you should expect from the six possible resistance measurements during out-of-circuit tests of non-defective transistors:

Measurement	Normal Ohms
B/E-forward	low
B/C-forward	low
B/E-reversed	high
B/C-reversed	high
C/E-forward	high
C/E-reversed	high

It's wise to replace both output transistors if one checks defective. The previous overload might cause a failure later. **In case you are forced to substitute a slightly-different type of transistor, replacement of both as a matched pair is mandatory, not optional.**

### Selecting replacement transistors

At times, exact replacement transistors might not be available, and the nearest equivalent must be selected. In addition to any physical differences, there are several characteristics that are of great importance; some of these are:

- The maximum breakdown voltage, especially VCEO (collector-to-emitter, with base open); this should be equal to, or better than, the rating of the original transistor. If you have no data, measure the no-load DC power-supply voltage, and add 20% to allow for high-line conditions;
- Power dissipation rating should be equivalent to that of the original;
- High-frequency cutoff should be equal to the original. If the HF response is excessive, oscillation might occur, causing distortion and extra power dissipation. Insufficient HF response can reduce the brilliance of music played through the amplifier; and
- Low-frequency common-emitter current gain should be approximately the same as the rating of the original transistor. The comparison of gain should be done at the average current, because this beta varies with C/E current. Particular



AUDIO FROM DRIVER

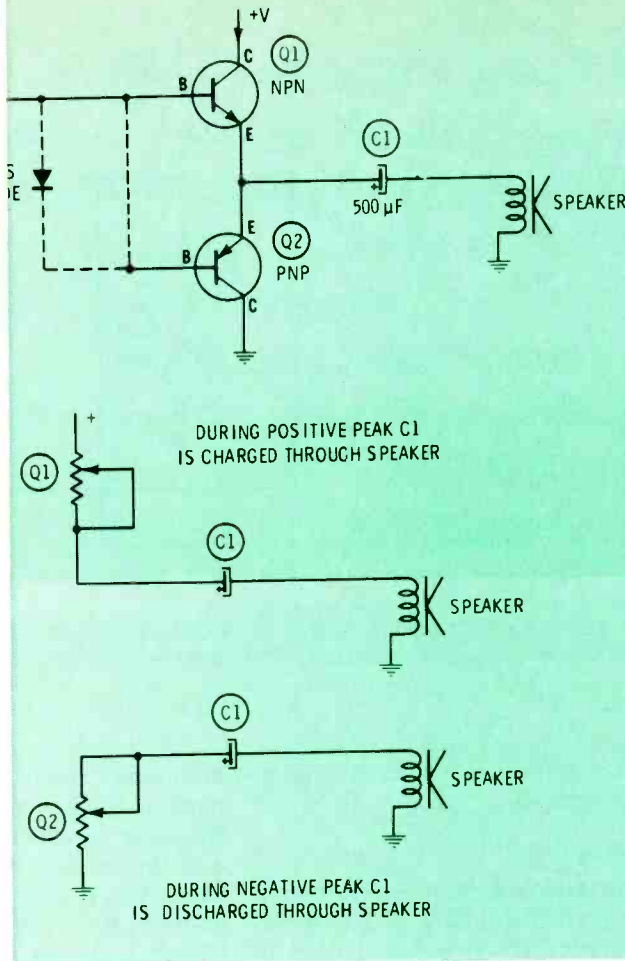

Fig. 5 Adding a coupling capacitor from the common emitters to the speaker terminal makes possible normal operation from just one power supply. DC voltage at the emitter should be about one-half that of the supply voltage. The two bases must have slightly different DC voltages so each will have forward bias of optimum voltage. Curiously, Q2 operates on voltage stored in C1 by previous conduction of

Q1. During positive peak C1 is charged through speaker. During negative peak C1 is discharged through speaker.

care should be taken in selecting the pre-driver transistor, which usually must be a high current-gain device. It might be possible to balance the output transistors if a poor choice of a driver transistor is made.

#### General Tips

When replacing output transistors on their heat sink, use a new mica insulator with a good grade of thermal grease on the sides. Tighten the mounting screws so they are tight, but not overly tight.

Any diodes mounted on the temperature compensation should be cleaned of dirt, if they are removed for tests, and then repositioned the same as before.

**Low-Frequency Testing**  
If all of the defective components

have been replaced, the amplifier should operate correctly. But, if anything has been overlooked and a serious defect still remains, the amplifier can blow parts again when power is applied. This is a real worry with solid-state components. Play it cautiously by adding a temporary resistor between the power source and the output transistors. A 10-watt resistor of 50 ohms or 100 ohms (depending on amplifier power) usually is adequate. At first, the tests should proceed without any audio signal (quiescent condition). Measure the voltage at the transistor end of the test resistor, as the power is applied. A low reading indicates excessive current. Without audio, a normal stage should show only a few volts dropped in the resistor. Measure the voltage at the common emitters.

ective components

have been replaced, the amplifier should operate correctly. But, if anything has been overlooked and a serious defect still remains, the amplifier can blow parts again when power is applied. This is a real worry with solid-state components.

Play it cautiously by adding a temporary resistor between the power source and the output transistors. A 10-watt resistor of 50 ohms or 100 ohms (depending on amplifier power) usually is adequate.

At first, the tests should proceed without any audio signal (quiescent condition). Measure the voltage at the transistor end of the test resistor, as the power is applied. A low reading indicates excessive current. Without audio, a normal stage should show only a few volts dropped in the resistor. Measure the voltage at the common emitters.

If it is approximately one-half that at the test resistor, it's probably safe to have the temporary resistor removed, and a full-power test made.

Operate the machine with no audio but with full B+ power for several minutes. Then feel the temperature of the two output transistors. Both should be about the same barely-warm temperature. If one is hot and the other cold, better turn off the machine and do more testing, before the hot one is destroyed.

#### Measuring Power Output

After the repaired channel appears to be operating correctly, the maximum undistorted power output should be checked. This is very easy, requiring only a sine-wave audio generator, an RMS-calibrated AC voltmeter, and an oscilloscope.

Disconnect the speakers from both stereo outputs and connect non-inductive load resistors as substitutes for the speakers. Power rating of the resistors should be higher than the expected audio wattage.

Using the circuit of Figure 6 as an example, connect the audio generator through a .1 microfarad capacitor to the base of Q203, and to chassis ground. The AC voltmeter and scope should be wired in parallel with the load resistor of the repaired channel.

Gradually increase the 400 Hz output of the audio generator. At first a small-amplitude sine wave should be seen, and the level should increase with the generator adjustment. Advance the control slowly until clipping of one or both tips of the sine wave occurs (see Figure 7).

Clipping of one tip only shows an unbalance, probably of the bias of the output transistors; in this event, more tests are indicated.

Clipping of both tips the same indicates a normal condition, but excessive input that is driving the output transistors into distortion. Reduce the output of the generator until the clipping barely disappears. Measure the RMS AC voltage. Figure the wattage by the formula of **Wattage equals Voltage-Squared divided by Value (in ohms) of the Load Resistor**. For example, 6 volts across an 8-ohm load resistor equals a power of 4.5 watts, and 8 volts equals 8 watts.

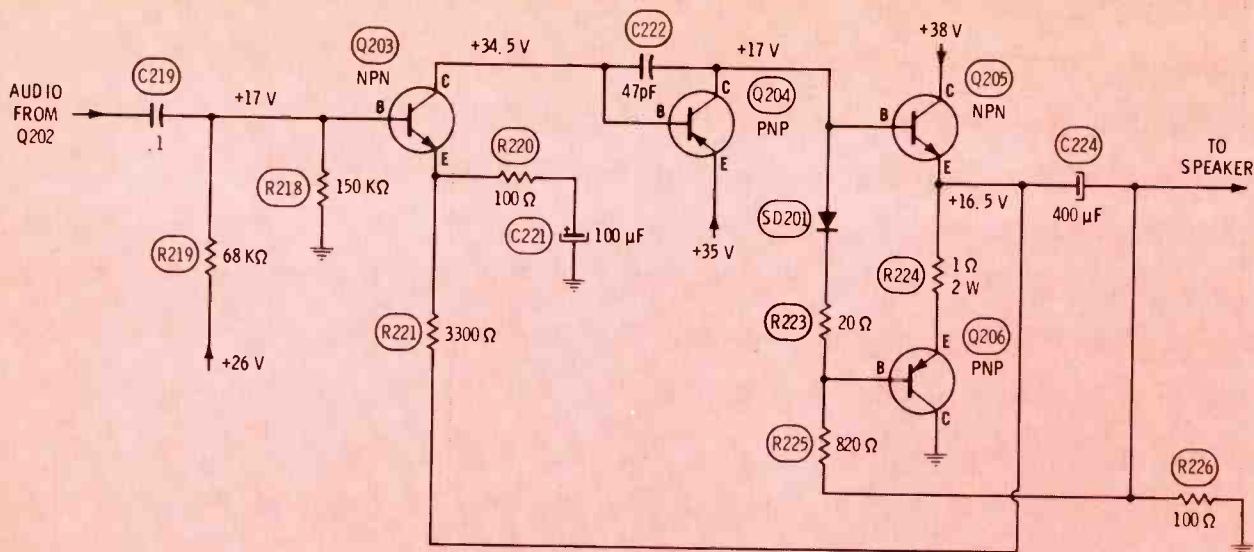

Fig. 6 This schematic of a Catalina Model 123-4686A (Photofact 1412-4) is typical of many commercial complementary-symmetry PNP/NPN audio output circuits.

For a valid comparison, measure the other channel (the one that did not have a defect) in the same way. The output voltage preferably should be no more than 10% higher or lower than the repaired channel. And the maximum power output should be nearly identical. Don't be surprised if the maximum power you measure is greatly lower than published specs. Perhaps the amplifier was manufactured before the government's new regulations regarding methods of testing amplifier power went into effect. "Music power", and other such ratings, result in inflated figures.

If you want to avoid call-backs,

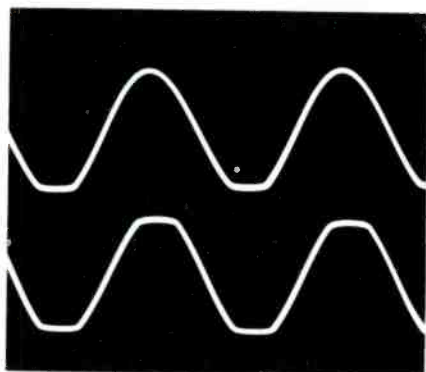

Fig. 7 Clipping of only one sine-wave peak indicates an unbalance of the two output transistors (top trace). When both peaks show identical clipping, the balance is good, but the generator level is too high, causing both output transistors to distort (trace at the bottom).

do one more test while the equipment is handy.

#### "Burning in"

Operation of these output transistors at about 63% of maximum undistorted power output results in maximum dissipation (at low levels the current is small; at loud levels, the transistors act much like on-off switches). So, reduce the generator level to give 63% of the power previously obtained in the test, and operate the amplifier on the resistive load for about an hour.

At the end of the hour, disconnect the audio generator, feel of the transistors to estimate the heating, and measure the no-signal current of the output transistors. It should be higher than before this heat run, and should slowly go down as the amplifier cools. Proper response to this test indicates good thermal stability, and there should be little chance of a call-back.

#### Keeping The Customer Happy

The amplifier has been repaired correctly and time-tested. Will it remain repaired? Partially, this depends on use or abuse of the machine by the customer.

It is well worth your time in hopes of minimizing call-backs to go over this checklist with the customer at the time of delivery:

- When switching functions (for example from phono to radio), turn down the volume or loudness to

minimum. This eliminates the loud pops or thumps that might blow a transistor or speaker;

- If the volume suddenly becomes weak, don't attempt to restore the volume by turning the control higher than the usual point. Instead, turn off the unit;
- Do not locate the amplifier unit where air circulation is restricted;
- Use speakers of the impedance recommended by the amplifier manufacturer;
- Never operate an amplifier with less than the rated load impedance at the speaker terminals. Be very careful of accidental shorts in any remote-speaker lines; and
- Don't operate the machine for long at levels so loud the sounds are distorted. Such extended operation could exceed the temperature tolerance of the output transistors.

#### Summary

In brief, these are the steps for successfully repairing solid-state complementary-symmetry stereo output stages: Replace all transistors and other parts proven defective by visual and power-off tests; apply current-limited power to check for shorts or unbalanced operation; restore the full power; and time-test the repaired amplifier at 63% of maximum undistorted power for an hour or more.

Please write to the editor, if you have questions or suggestions for additional information. □

# OHM ON THE RANGE!

You know electronics, so have fun solving the Just-Across-Word Puzzle based on that subject. Each word is connected with the word above and below by one or more letters although only one is usually shown as a clue. Each correct answer is worth 4 points; a perfect score is 100. It should prove fairly easy, except perhaps for someone who thinks "armature" is an athlete who performs without pay, or that "Heaviside Layer" is the problem of the obese! Make yourself comfortable and GO!

by Edmund A. Braun

1. Using parts removed from one system to use in a similar system.
2. Pertaining to black and white television.
3. The direction of high speed electrons at an electrode.
4. Electric discharge through an insulator, in a situation on wire, etc.
5. Repairing or adjusting electronic equipment.
6. The difference between the actual and specified values of a quantity.
7. Antenna having maximum response in two opposite directions.
8. Part of a magnetic structure opposite the armature.
9. A type of separated variable frequency resistor.
10. To ascertain by checking any variation in loading of another meter.
11. Ability of a circuit or antenna to be useful over a large frequency range.
12. Thermionic diode whose discharge is controlled by an external magnetic field.
13. Done without conscious thought or volition.
14. Propagation of energy through space or a material.
15. Making, breaking, or changing connections in an electrical circuit.
16. Accessory tool used with a drill press to cut large holes in metal or wood.
17. Having five times the speed of sound.
18. One essential part of a subsystem or equipment.
19. Having two tubes enveloped in the same envelope.
20. Instrument which measures radiation.
21. A circuit that responds in accordance to oscillations in another circuit.
22. Gauge for measuring pressure of gases.
23. Difference between limiting frequency of a continuous frequency band.
24. Tubular raceway for holding cables, wires, etc.
25. A nickel-steel alloy used for resistance wire.

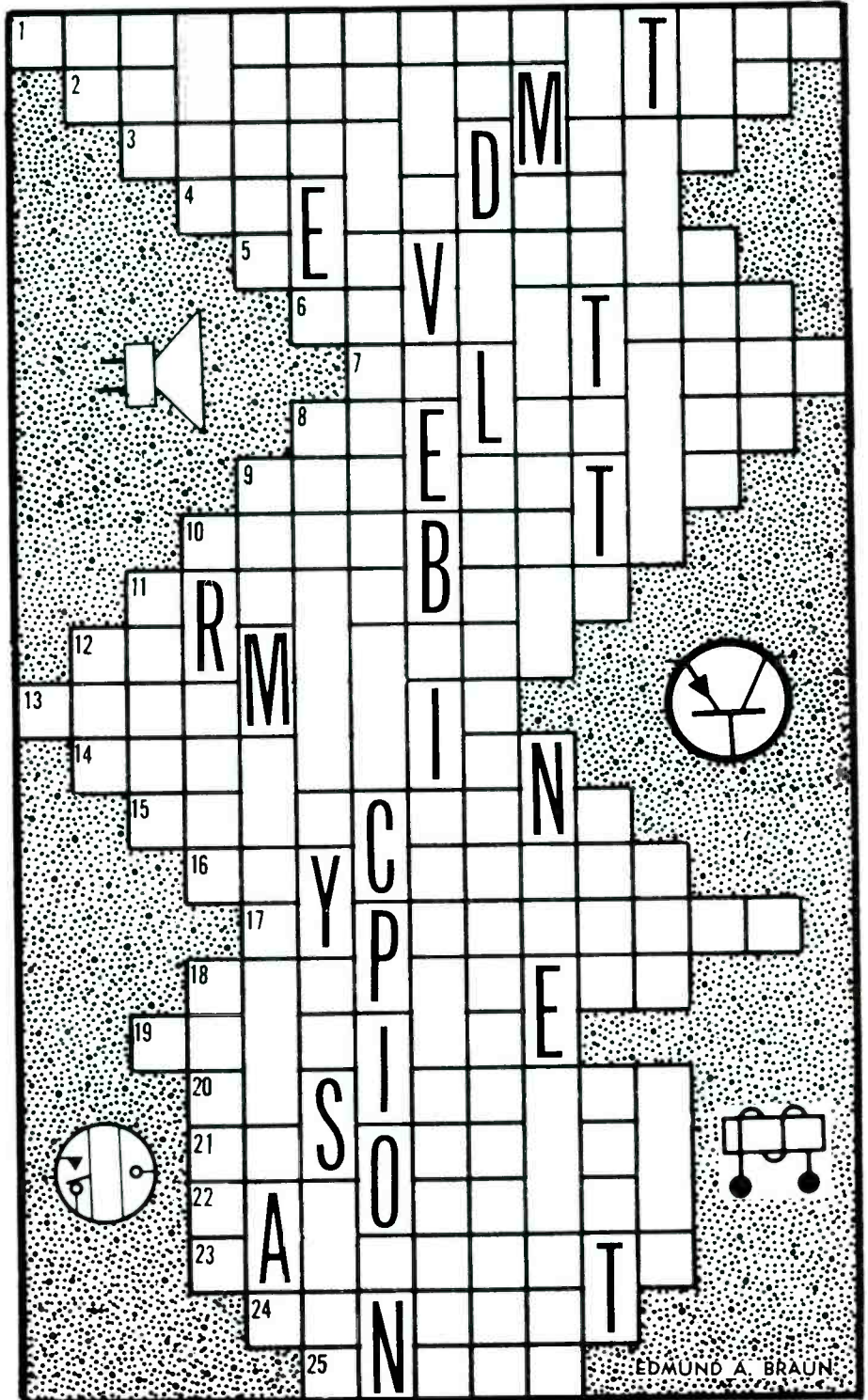

Don't peek 'til you finish, but the solution's on p. 57.

EDMUND A. BRAUN



1—An acceptable TV picture should have: full size with good linearity; sharp detail and focus; normal brightness; sufficient contrast and no snow. Locking should be solid, without rolling or pulling.

# CLUES FROM THE "BIG" SCOPE

By Carl Babcock, CET

*According to the old saying, "A picture is worth a thousand words". So, we should not overlook the value of information readily available from the screen of the picture tube.*

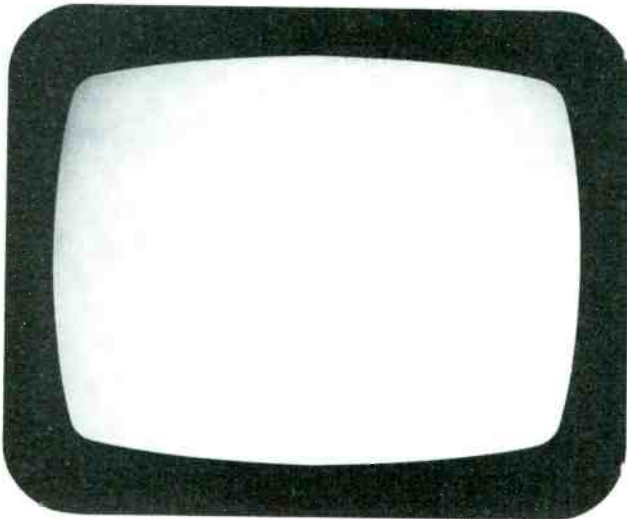

2—A bright raster without any snow on an unused channel indicates low gain, although sometimes the receiver has good pictures on strong signals. However, no snow and no picture on any channel means a total loss of signal. If the sound is okay, the tuner probably is working, so the defect likely is in the video IF's or the video amplifiers.

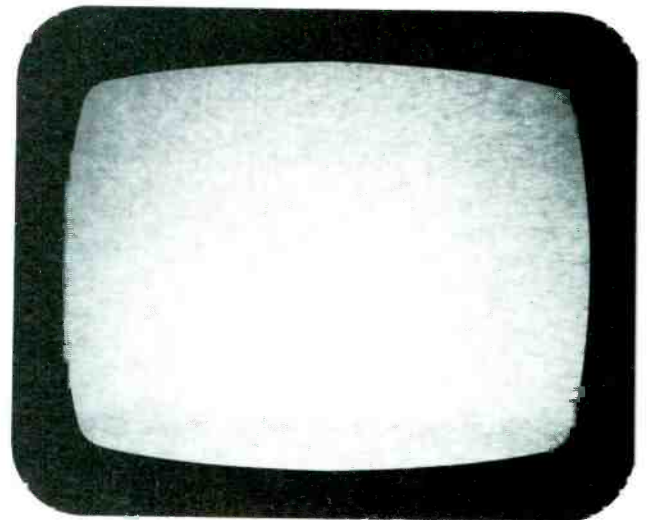

3—Heavy, sharp snow is normal for modern high-gain receivers. However, if there's no sound or picture on any channel, the antenna system might be bad, or the tuner oscillator might be dead.

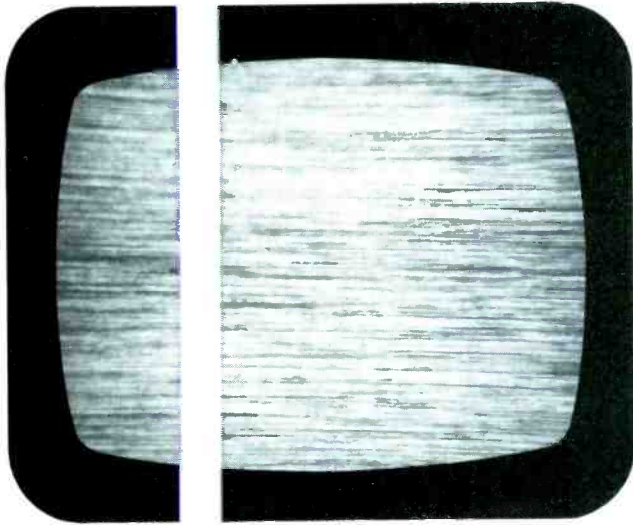

4—If the off-channel snow seems to be in streaks, it probably indicates the IF stages are on the verge of self-oscillation. AGC action on strong signals minimizes the picture degradation, so sometimes pictures of fair quality (but never the best) can be obtained. The streaks of snow are a real warning signal, for the situation probably will come worse.



6—Two light or dark round-edged horizontal bars floating up the picture are proof of 120-Hz hum. The frequency indicates a filtering defect in a full-wave power supply. Often these are called "hum bars".

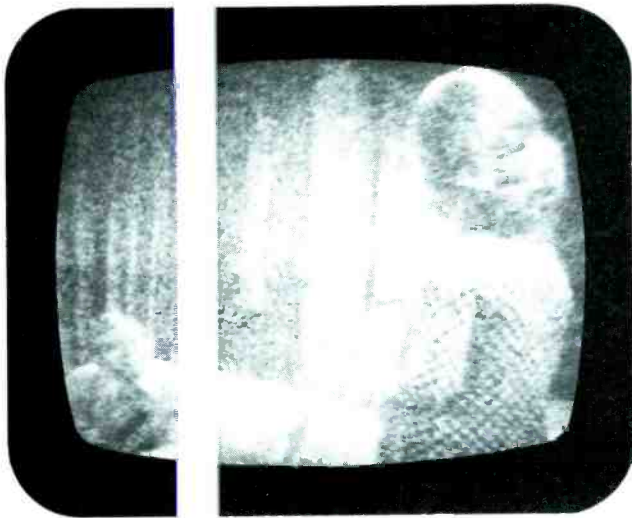

5—Excessive snow, but all other picture qualities OK, might be caused by a weak antenna signal, open antenna coil, or low gain in the RF stage. One overlooked cause of snow on a strong signal is too much AGC gain reduction applied to the IF tube or transistor.



7—One light or dark large hum bar with rounded edges moving slowly up the picture usually is caused by a sine-wave 60-Hz voltage getting into video or chroma circuits, possibly by heater-to-cathode leakage in a tube. If the bar is not so wide (tall), it might be caused by insufficient filtering of the DC voltage from a power supply that does not double the ripple frequency.

# CLUES FROM THE "BIG" SCOPE

(continued)

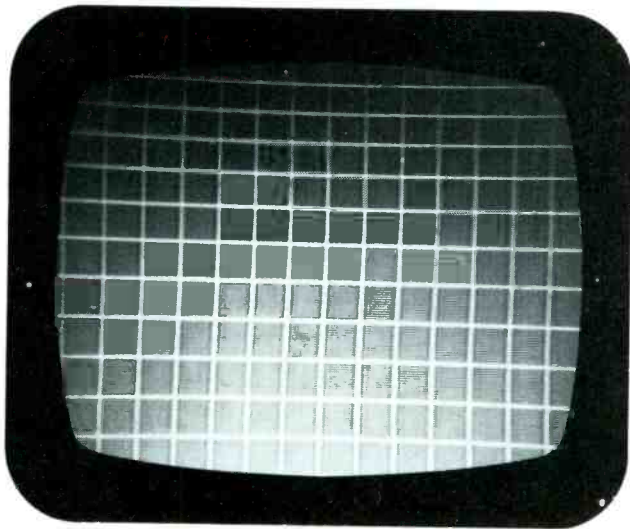

8—A picture that's darker at the top has "shading" from a vertical signal entering the video circuit. Hum moves with the picture as you roll it, using the hold control; shading stays in the same position on the raster. Shading might be caused by a vertical-blanking defect or a power supply problem allowing sweep into the video.

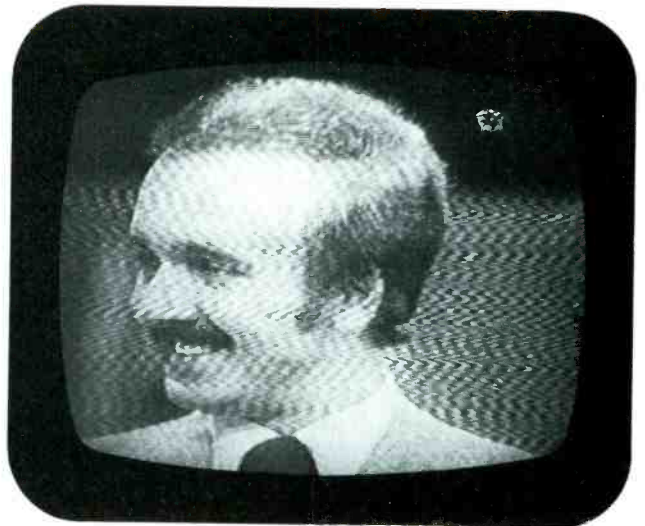

10—Large herringbone patterns only in picture areas that are in color is the 920-KHz beat between the 3.58-MHz color signal and the 4.5-MHz sound carrier. Wrong fine tuning adjustment, poor IF alignment (especially the traps) are two possible causes. Some kinds of interference from another strong TV-station carrier will appear somewhat similar.



9—Tiny black-and-white noise specks in the picture prove there's an arc somewhere. It might be in a bad regulator plate cap, or inside a ceramic capacitor in the horizontal-sweep circuit. Or it might come from outside the set. Source of the noise shown in the picture was a brush-type AC motor; proof is the bunching of the specks and lines into one group.

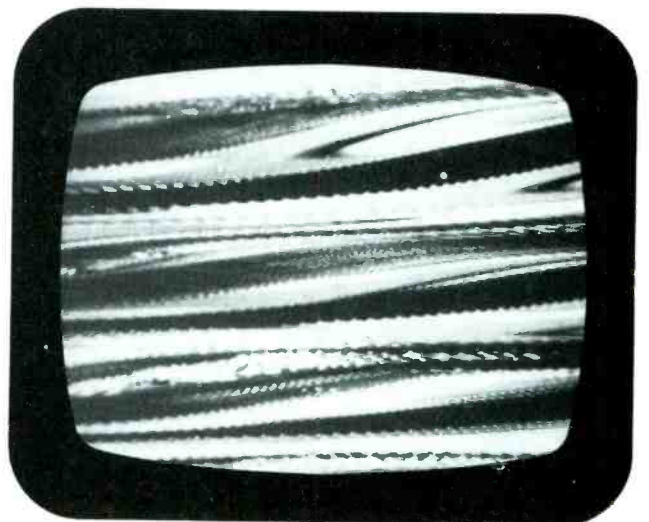

11—Out-of-lock horizontal sweep produces several pictures turned sideways into diagonal stripes. The blacker stripes are the horizontal-blanking bars (normally not seen), and they are useful in determining the approximate frequency. Each represents a 60-Hz error. Therefore, when you adjust the horizontal-hold control, fewer black diagonal bars means you are approaching the correct frequency where locking can occur.

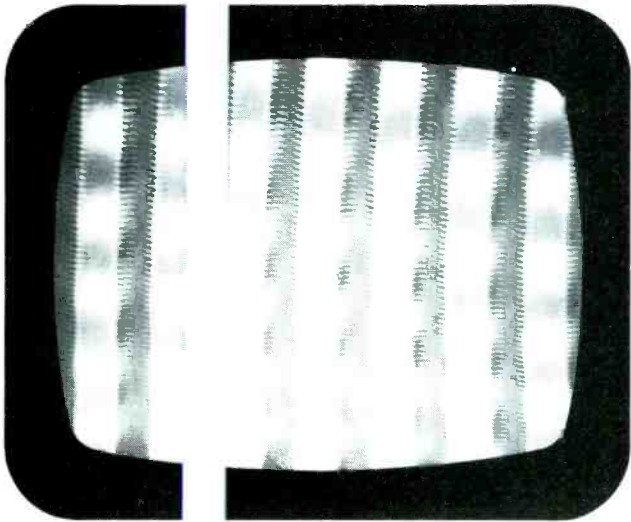

12—Color bars that are out-of-lock display vertical stripes, with the lines present only where the bars are supposed to be. As in the case of the horizontal locking, fewer diagonal dotted stripes of color indicate that the frequency is nearer correct.

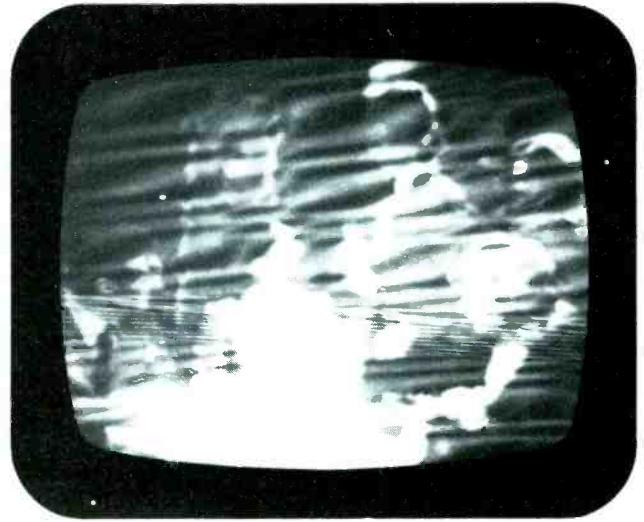

14—Interference patterns come in all shapes. This one was caused by the loose-coupled signal from a crosshatch generator tuned to the same channel.

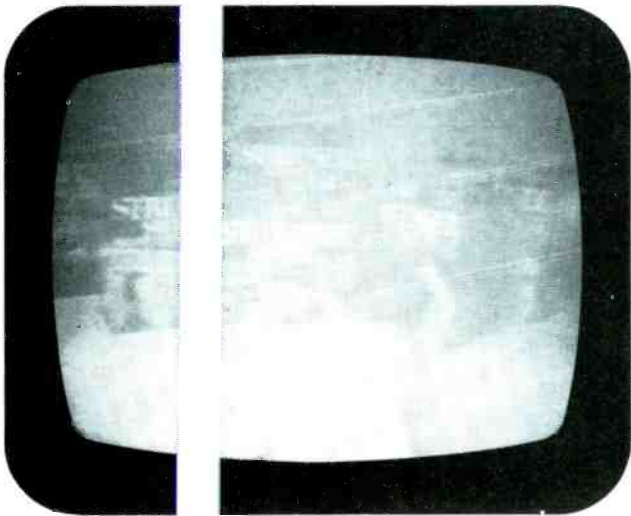

13—Thin vertical lines slanting up to the right are vertical-race lines produced by the moving from the bottom to the top of the screen. Normally, they are blanked out either by the vertical-blanking part of the composite video, or by vertical-retrace blanking that's fed to the video amplifier stage. These lines were caused by an open capacitor in the retrace-blanking circuit.



15—Interference that is not phase locked to the sweep frequencies (such as radiated noise from HV arcs, etc.) often appears in a Figure "S" shape. Most such lines are narrow; these were made wide by using a carrier modulated by square waves.



**16**—Excessive contrast can result from misadjusted AGC and contrast controls, or perhaps from a borderline defect in the AGC circuit. The composite video is negative-going; therefore, too much video causes a darker picture.

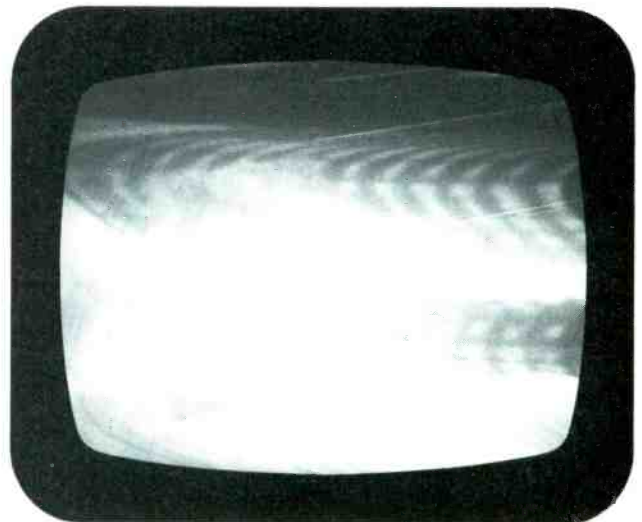

**18**—AGC failure? No, the only similarity is the picture bending. The picture is light, and in some cases will be darker on the right edge. Symptoms were caused by an open filter capacitor, the one bypassing the B+ to the damper tube.

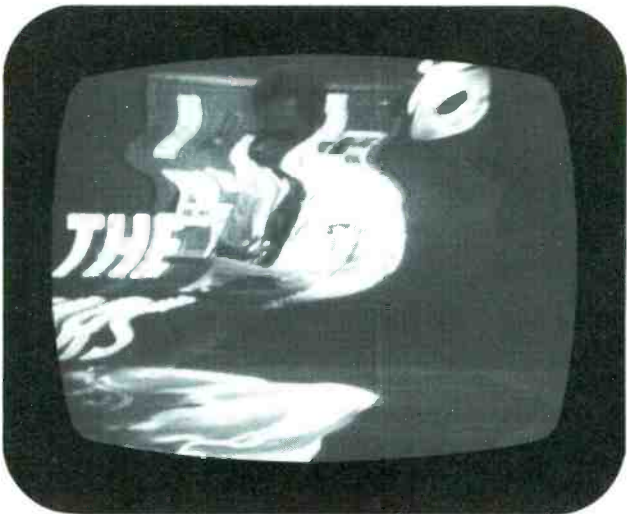

**17**—Defective AGC produces clipping of the signal at the sync and black-level side. Output of the sync separator has video in it which produces severe picture bending. Contrast is excessive, but not as bad as it would be if there were no clipping of the blacks. Tip: AGC failure still permits good snow off channel; tuner or IF defect causing clipping reduces off-channel snow.

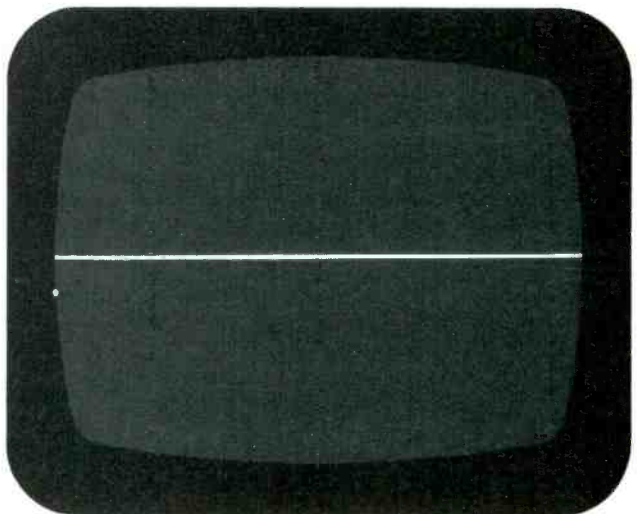

**19**—Loss of vertical sweep is a common problem, giving a horizontal line across the screen. One defect that's tough to find is an intermittent open, or severe leakage from terminal to case, inside the setup switch. When all else fails, try this.



# CLUES FROM THE "BIG SCOPE"

(continued)

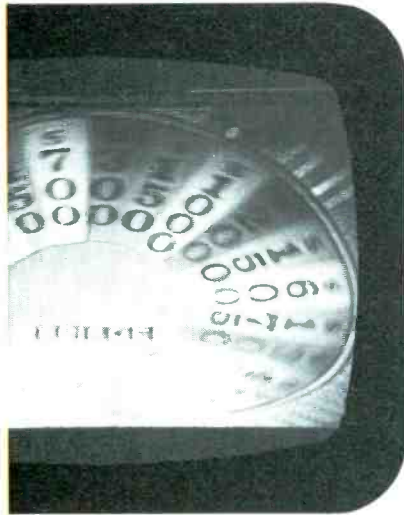
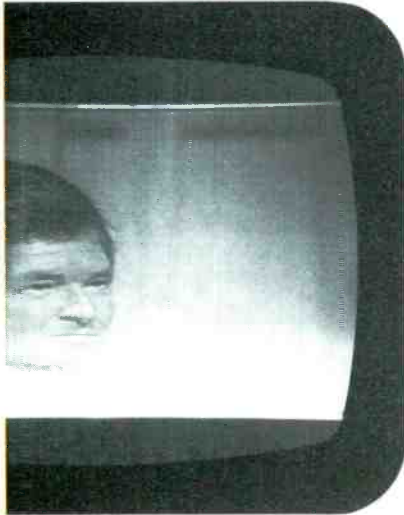

20—Do both pictures show the effects of the same parts defect? No, in the top picture, a leaky coupling capacitor compressed the last two inches of the picture. The lower picture showed insufficient height because a plate resistor had increased in value. All of the picture was present at the bottom of the dial, but the linearity was compressed. These slight differences can be valuable clues

21—Don't say the vertical was out-of-lock. It was locked solidly—but at the wrong frequency! Therefore, the main problem was of wrong frequency, not lack of sync for locking.

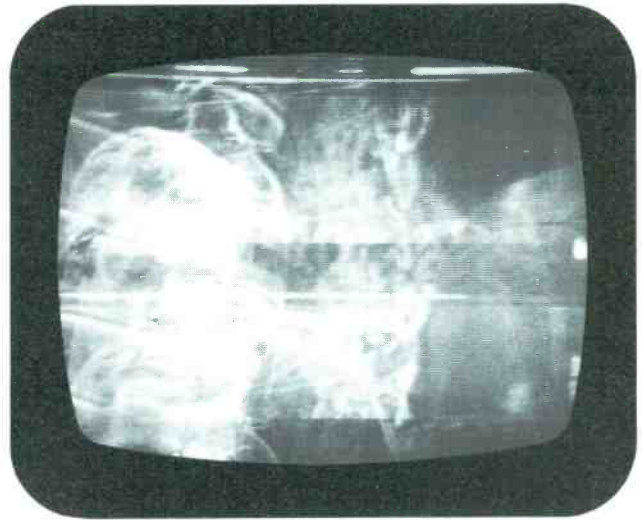

21—Don't say the vertical was out-of-lock. It was locked solidly—but at the wrong frequency! Therefore, the main problem was of wrong frequency, not lack of sync for locking.



22—This picture is out-of-lock vertically. Perhaps there was too little vertical sync amplitude. If you adjusted the vertical-hold control so the picture moved upward and it locked solidly, then the sync is okay, but something had caused the frequency to run too fast. However, if the picture can be moved upward, and it does not lock, the sync is missing. Generally speaking, rolling down means the frequency is too fast, rolling up means it is too slow, and motionless means it is correct. □

# Servicing Modular Color

Part 4/By Charles D. Simmons



*Continuing with the circuits and servicing of the Zenith 19EC45 series of color TV portables, the video amplifiers and AGC are featured. Special circuits include two kinds of retrace blanking, two separate raster blankers, and a brightness-limiter stage.*

Video amplifier stages in most TV receivers offer very little of interest. Not so with the Zenith 19EC45 and 19FC45 series of color portables. Here is a preview of some video features:

- Video and AGC stages are found in the IF module and 3 Duramodules
- The brightness-limiter circuit prevents excessive picture-tube current
- The raster is blanked also when the vertical yoke current ceases
- Pre-CRT matrixing combines the b-w and chroma signals before the true red, blue, and green signals are sent to the cathodes of the picture tube

- A single IC supplies vertical and horizontal sync, IF AGC, and two kinds of RF AGC (for transistor or FET).

Locations of the modules containing video stages are shown in Figure 1.

## 150-190 IF Module

Output of the video-detector diode is a positive-going composite video signal which is direct coupled to the base of Q106, the 1st video amplifier transistor. In turn, Q106 is direct coupled to Q104, the 2nd video-amplifier transistor, an emitter follower. Output from the emitter of Q104 is a negative-going video signal at terminal W5 of the 150-190 IF module. Terminal W5 is called C1, in typical Zenith fashion, and the signal from there goes to the video processor, luminance, and chroma modules (see Figure 2).

Also, two diodes in a voltage-doubler circuit supply a negative-going video signal to terminal W1 (C2 in older Zenith terminology) for use by the sound module.

## 9-88 Luminance Module

Terminal W7 is the video input for 9-88 module (refer to Figure 3). Non-polarized capacitor C903 passes all of the video along to the contrast control (mounted on the chassis), while R903 and R909 reduce the amount of DC voltage. The contrast control is a simple AC potentiometer that varies the video before it is applied to the base of Q904.

Notice that the low end of the contrast control is connected to the brightness-limiter wiring, so any excessive picture-tube current changes the base voltage (bias) of

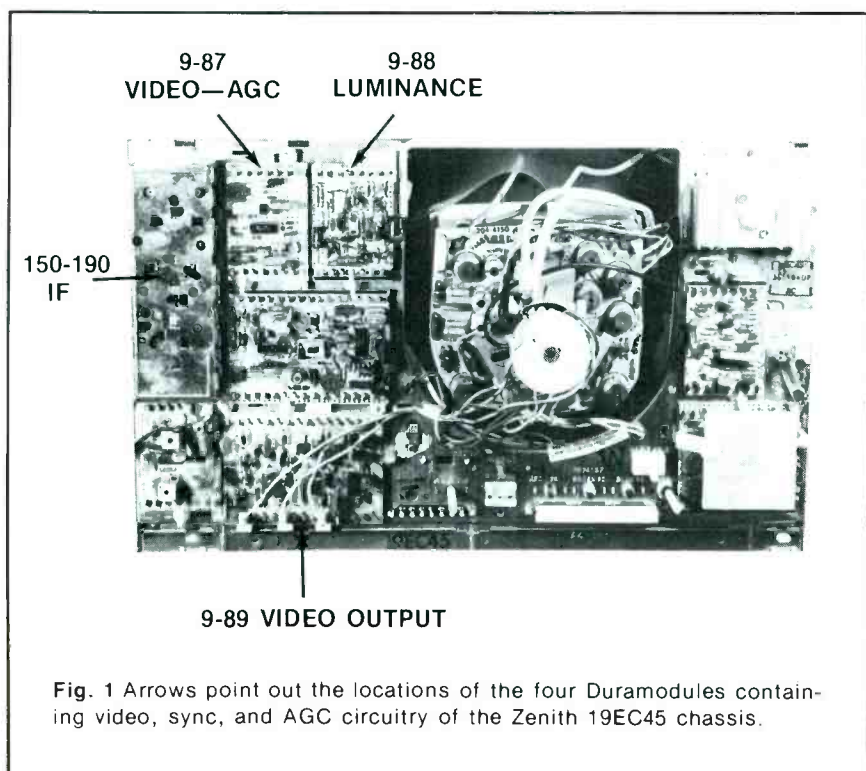
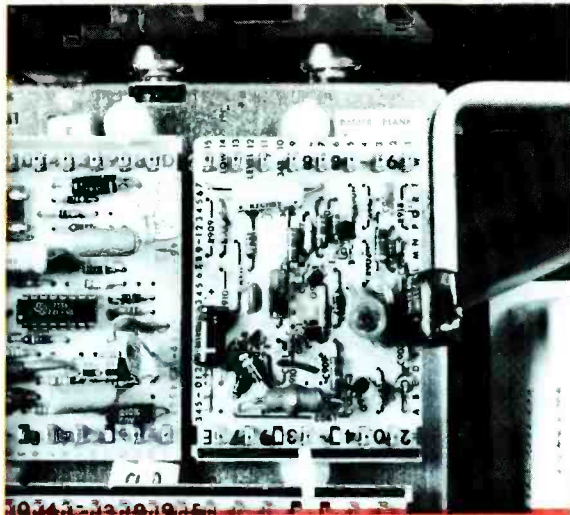

Fig. 1 Arrows point out the locations of the four Duramodules containing video, sync, and AGC circuitry of the Zenith 19EC45 chassis.



Top row terminals on the 9-87 module (left in picture) start with U14 at the left edge by even numbers to W15 at the right. Bottom terminals go from W1 at the left edge by odd numbers to U14 at the right. Top row of terminals on the 9-88 module (at right) starts with W15 at the left edge and go by odd numbers to W1 at the right. At the bottom terminals go from U14 at the left by even numbers to U2 at the right.



Bottom terminals on the 9-87 module (left in picture) start with U14 at the left edge by even numbers to W15 at the right. Bottom terminals go from W1 at the left edge by odd numbers to U14 at the right. Top row of terminals on the 9-88 module (at right) starts with W15 at the left edge and go by odd numbers to W1 at the right. At the bottom terminals go from U14 at the left by even numbers to U2 at the right.

Q904 in a positive-going direction. Action of the brightness limiter will be explained later.

#### Vertical blanking

Many signals and voltages are applied to the emitter of Q904. It has the 3.58-MHz frequency response to obtain peak brightness, vertical blanking pulses are applied to accomplish vertical blanking. When vertical sweep is lost, and vertical blanking is applied by the raster blanking control when it is wanted.

Q901 amplifies and clips the vertical pulse obtained from the vertical oscillator (Figure 4). Component values in the base circuit determine the amplitude and waveform of the pulses there. For example, if C1 and C2 were changed to a much larger value, the top of the raster would be darker than the bottom. Output goes to the base of Q903, which is wired as an emitter follower that drives the emitter of Q904. Negative-going pulses at the base of Q901 are positive-going at the emitter of Q904, biasing it to cutoff, and in turn eliminating the brightness during vertical retrace times. As mentioned before, a more-positive voltage from the brightness control applied through R915 is used to adjust the brightness level.

positive (negative-going) direction. Action of the brightness limiter will be explained later.

#### and raster blanking

and voltages are applied to the emitter of Q904. It has the 3.58-MHz frequency response to obtain peak brightness, vertical blanking pulses are applied to accomplish vertical blanking. When vertical sweep is lost, and vertical blanking is applied by the raster blanking control when it is wanted.

Q901 amplifies and clips the vertical pulse obtained from the vertical oscillator (Figure 4). Component values in the base circuit determine the amplitude and waveform of the pulses there. For example, if C1 and C2 were changed to a much larger value, the top of the raster would be darker than the bottom. Output goes to the base of Q903, which is wired as an emitter follower that drives the emitter of Q904. Negative-going pulses at the base of Q901 are positive-going at the emitter of Q904, biasing it to cutoff, and in turn eliminating the brightness during vertical retrace times. As mentioned before, a more-positive voltage from the brightness control applied through R915 is used to adjust the brightness level.

Q901 are positive-going at the emitter of Q904, biasing it to cutoff, and in turn eliminating the brightness during vertical retrace times. As mentioned before, a more-positive voltage from the brightness control applied through R915 is used to adjust the brightness level.

One function remains, that of a raster blackout when the vertical yoke current is lost. A sawtooth waveform from the yoke current is connected to U2 (Figure 4). It is applied to the base of Q905, which has no DC forward bias, and the negative-going part of the sawtooth biases Q905 into conduction. This conduction makes the collector of Q905 positive, the voltage is filtered to remove most of the AC, then is applied as forward bias to the base of Q901.

If the vertical yoke current stops, Q905 is biased to cutoff, thus removing the forward bias from Q901. When Q901 has no forward bias, the collector becomes more positive, and this voltage increase is passed down the video stages until it finally makes the cathodes of the picture tube about 50 volts more positive, reducing the brightness.

#### Horizontal blanking

Output from the collector of Q904 is positive-going video that has good vertical blanking, and this signal feeds the delay line. At the output of the delay line, horizontal-blanking pulses are added (Figure 5).

Positive-going horizontal pulses come in through R215, any excess above 24 volts peak is clipped by conduction through diode CR218, and the remainder of the pulses go through CR217 and reach the output of the delay line. As we'll see later, a more-positive voltage here makes the cathodes of the picture tube more positive, thus reducing the brightness.

The delay line, resistors, diodes, and the setup switch are on the chassis, rather than on a module.

The video, now with vertical and horizontal blanking pulses, goes to terminal W1 of module 9-87. But first, we should go back to the brightness-limiter circuit.

#### Brightness Limiter

If the load current of any peak-reading rectifier system increases, the ripple amplitude increases also. An application of that fact supplies the signal which senses the amount of HV current drawn by the picture tube.

Components inside the tripler assembly bring out a sample of the ripple to the REF terminal (Figure 6). R230, R236, and the BRIGHTNESS LIMITER control, R234, determine the amount of the ripple that reaches the base of Q902. The ripple is the only forward bias Q902 has. Waveforms of the ripple are shown in Figure 7.

When the picture-tube current is moderate, Q902 is cutoff, so the collector voltage is determined by the voltage divider, R910 and R905. The collector voltage is connected to the low end of the contrast control, and through the following direct-coupled stages to the picture tube, where it plays a large part in determining the picture brightness.

If the picture-tube current becomes excessive, for any reason, the amplitude of the ripple at the base of Q902 increases, causing the collector of Q902 to draw current, reducing the DC voltage to the contrast control, and decreasing the brightness. The action is much like

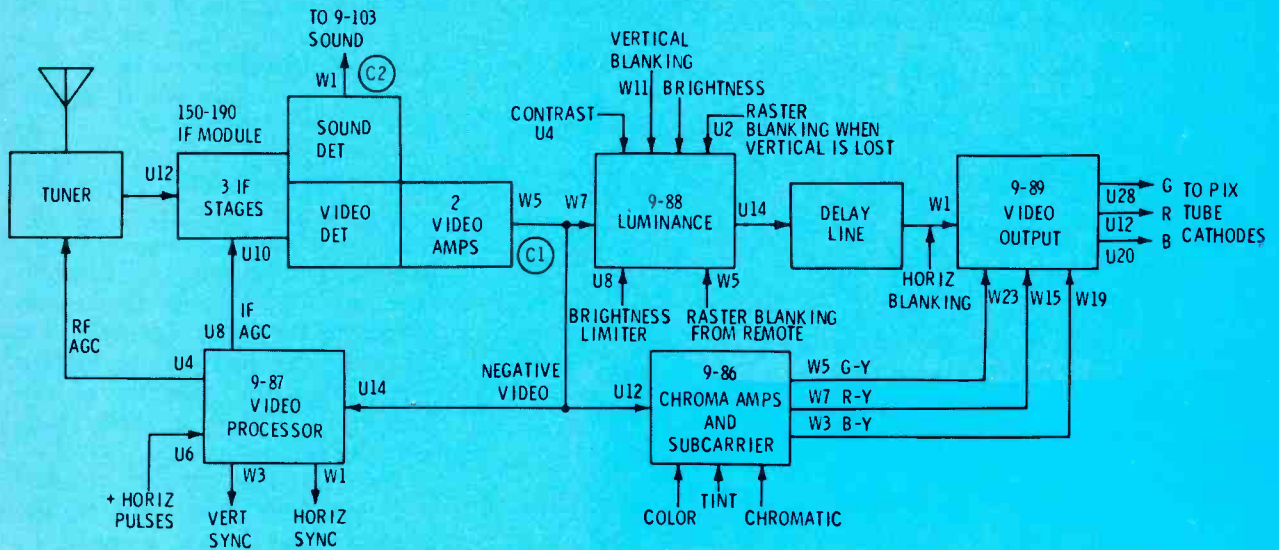

Fig. 2 This block diagram shows the major modules and components, along with the terminal numbers.

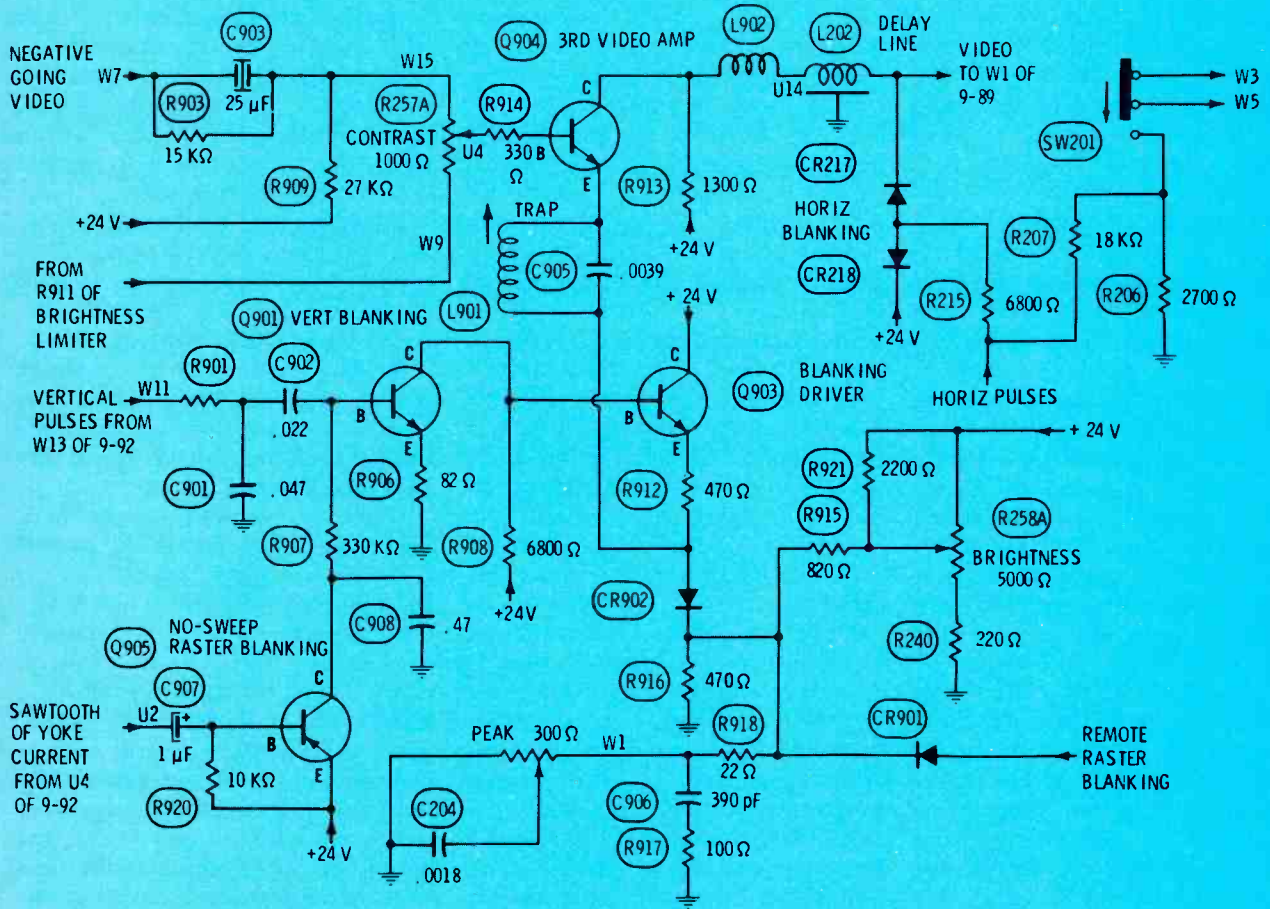
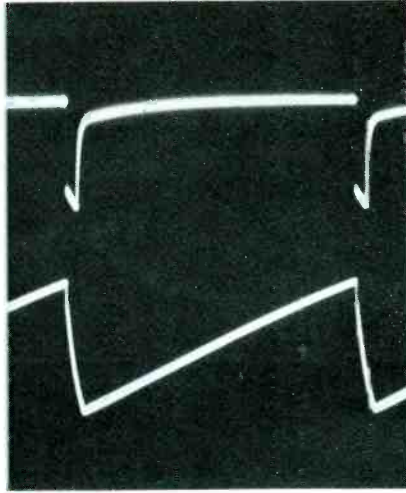

Fig. 3 The 9-88 module has only one amplifier stage, but it has many other circuits, such as horizontal blanking, vertical blanking, contrast, brightness, and the raster blanking that happens from loss of vertical sweep.



Fig. 4 Top waveform is the signal from the vertical oscillator that goes into terminal W11 for vertical blanking (12 V PP) (from the vertical sync current) applied to terminal U2 of the raster generator (about 4 V PP).



Bottom waveform is the video at the contrast control, before blanking is added, and bottom waveform is the video at the delay line after horizontal blanking has been added.

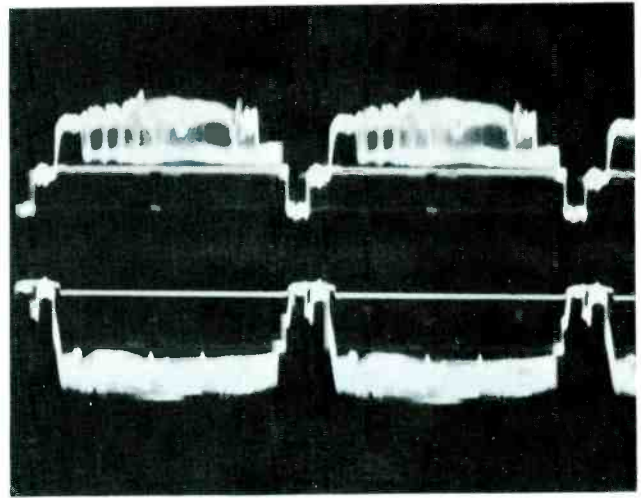

Fig. 5 Waveform at the top is the video at the contrast control, before blanking is added, and bottom waveform is the video at the delay line after horizontal blanking has been added.

that of AGC. It filters out any amplified ripple from Q902.

Loss of the benefit would be significant, and perhaps shorten the life span of the picture tube.

### Matrixing on Module 9-89

Part of the switch wiring is shown in Figure 3, and part in Figure 8. In this setup position, R206 and R207 apply the emitters of the three color output amplifiers to the delay line (there is no horizontal blanking at that time, and no vertical blanking).

Positive-going video from the delay line is applied to the base of

Q902, which filters out any amplified ripple from the collector of Q902.

Brightness-limiter circuit prevents some blooming and shortens the life span of the picture tube.

### Module 9-89 and CRT Drive

Part of the switch wiring is shown in Figure 3, and part in Figure 8. In this setup position, R206 and R207 apply the emitters of the three color output amplifiers to the delay line (there is no horizontal blanking at that time, and no vertical blanking).

Positive-going video from the delay line is applied to the base of

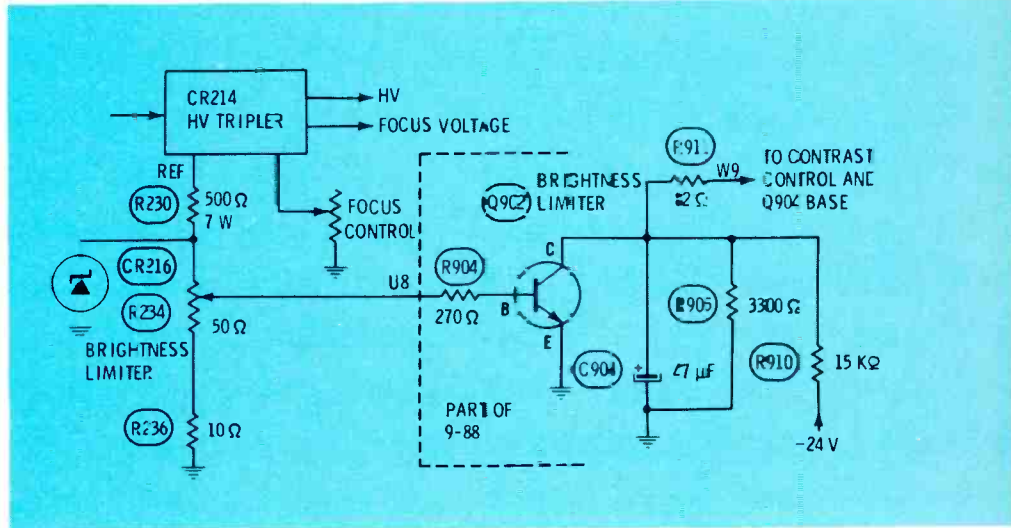
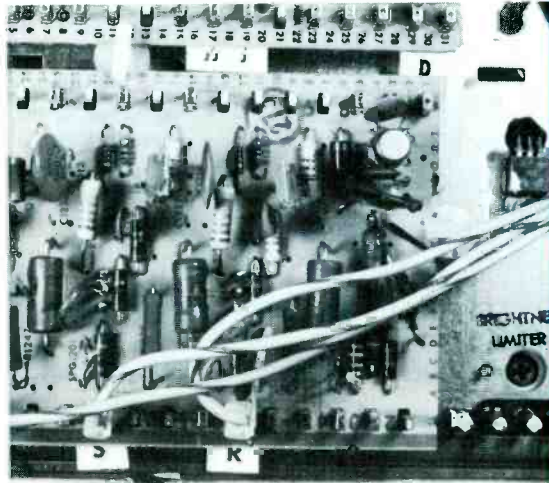

Fig. 6 Ripple from the HV tripler increases at high brightness. At a certain level the ripple forward biases Q902 and reduces the positive voltage at the contrast control. In turn, this reduces the brightness to prevent blooming.



The top row of terminals on the 9-89 module are numbered W31 at the left edge and go by odd numbers to W1 at the right. Bottom terminals start with U30 at the left and go by even numbers to U2 at the right edge.

Q1204, which is wired as an emitter follower. Zener diode CR1202 provides a path for the emitter when the setup switch opens that circuit, and it also functions as a protective device in case of arcs.

Positive-going video from the emitter (no phase reversal in a follower) goes to the setup switch, then back to R1242 (and the

emitter resistors for Q1205 and Q1207) where it is applied to the emitter of Q1206, the red-video output transistor, whose collector is direct coupled to the red cathode of the picture tube.

Three gain taps are provided for adjusting the amount of signal from Q1206 to the CRT cathode to permit good gray-scale tracking.

Some taps and a spark gap made of paralleled wires are shown in Figure 9.

#### Matrixing of the chroma

R-Y signal from the chroma demodulator is applied to the base of Q1206, and the b-w (luminance) signal is applied to the emitter. Matrixing of the two signals into a

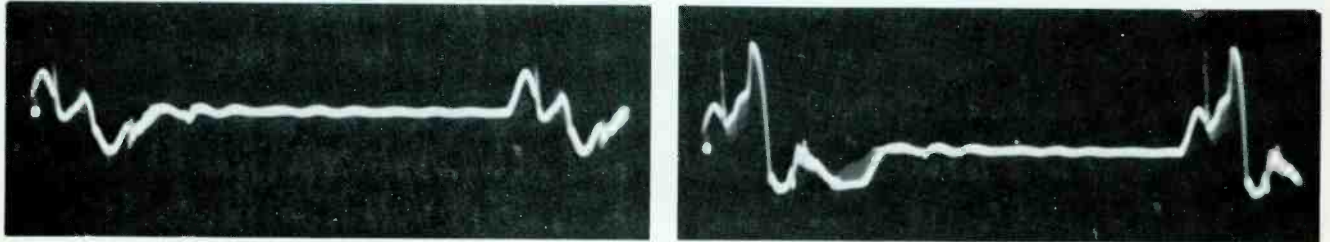

Fig. 7 Waveform in the left picture was observed at the brightness-limit control when the brightness was moderate. After the brightness was raised to maximum, the ripple more than doubled in amplitude, as shown in the right picture.

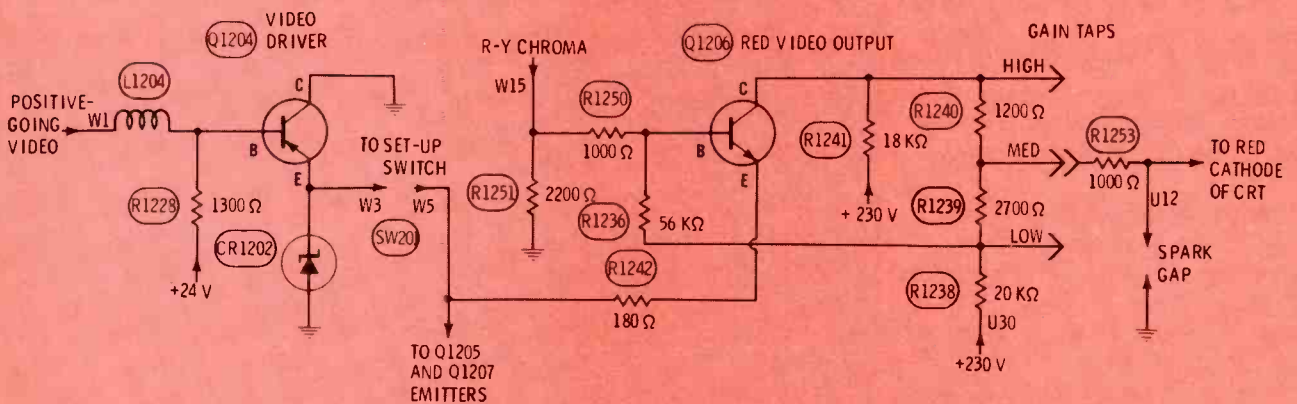
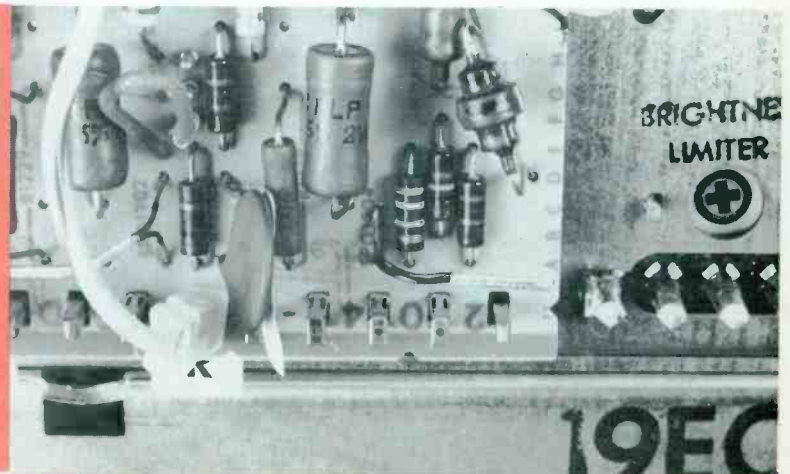

Fig. 8 Only one of the three color output transistors is shown here. Video from the video driver transistor goes to all three emitters, while separate -Y signals go to the bases of the output transistors. Matrixing is done inside Q1205, Q1207, and Q1206. Module terminals are used as tie points for three amplitudes of drive to the picture tube. The setup switch connects W5 to fixed resistors so the output transistors have a constant bias and no video during gray scale adjustments.

Fig. 9 Spark gaps on the 9-89 video-output module are made of paralleled lengths of wire. Some of the terminals are used as taps to select the amount of color drive giving best gray scale tracking. The brightness-limiter control is located on the chassis just to the right of the 9-89 module, and the three lugs just underneath it connect to the three connections of the pot.



true red signal inside the transistor. Remember, chroma and blue waveforms, plus strong, wide vertical blanking pulses. The appearance of the picture tube cathodes is applied to the waveform is shown in Figure 10.

is accomplished at the combined waveforms, plus vertical and horizontal blanking pulses. The signal at the cathodes (no AC signal grids). A sample waveform is shown in Figure 10.

Three AGC voltages are supplied by the IC. For the RF stage in the tuner, one is negative-going for an FET, the other is positive-going for a transistor. The IF AGC is positive-going (about +4.4 with no signal, and +7 volts with a moderately-strong signal). This voltage is adjustable by a potentiometer; however, the action is to determine the gain reduction of the RF stage. So, it is adjusted on weak stations for minimum visible snow in the picture. There are no other adjustments on the 9-87 module.

tube has been explained, along with the sync and AGC systems which are tied in with these circuits. Direct coupling brings extra problems when you try to analyze the stages by using a DC meter to check for troubles. However, this is NOT a closed loop system. Therefore, a defect can change all the DC voltages following it, but is not likely to change those ahead of it.

### Sync and AGC on Module 9-87

All of the sync and AGC functions are performed inside one IC on the 9-87 module called Video Processor. Negative-going video enters at terminal U14, and horizontal pulses enter at terminal U6 (Figure 11).

### Waveform Analysis

Vertical sync comes out at terminal W3, and terminal W1 has negative-going horizontal sync.

If C401, the IF AGC bypass electrolytic, opens, the picture is covered by horizontal lines (Figure 12).

Waveform analysis of the various module terminals (that are shown in the block diagram of Figure 2) is the recommended method to be used until the defective stage is located.

### Next Month

Chroma circuits on the 9-86 chroma Duramodule will be next month's subject for analysis. □

### Summary

The video path from detector diode to cathodes of the picture

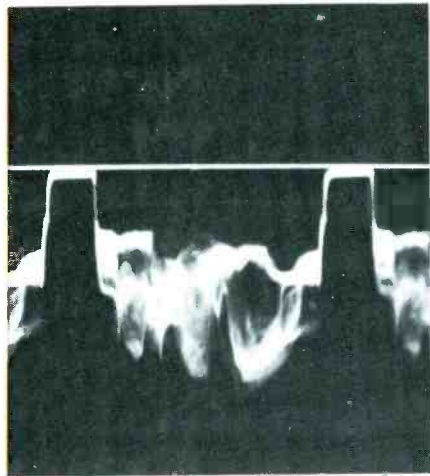

Fig. 10 Waveforms at the picture-tube cathodes are different from those seen in many color TV's. Wide blanking pulses are there plus both b-w and color signals. The one shown is the 110 V PP waveform at the red cathode.

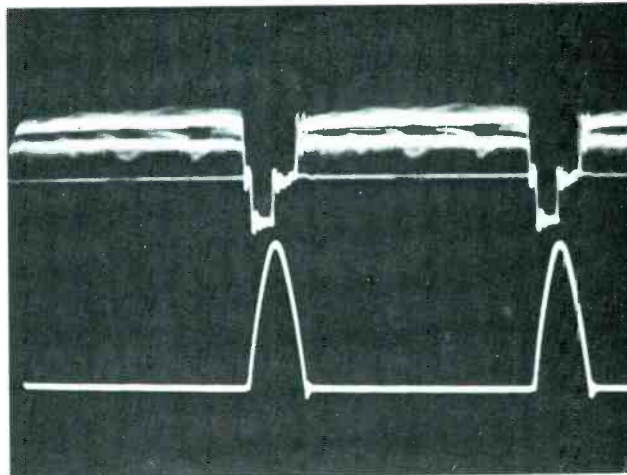
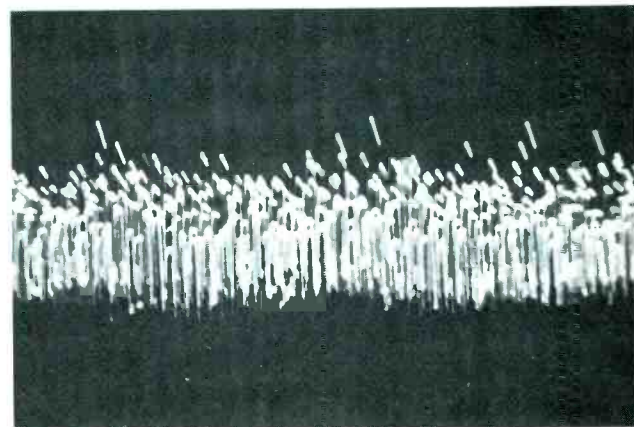

Fig. 11 Waveform at the top is the 4.5 V PP one at terminal U14 of module 9-87, while the bottom trace shows the 8 V PP positive-going AGC-keying pulses at terminal U6.



Fig. 12 The left picture shows the strong horizontal white lines that flash erratically across the screen when C401 (IF AGC bypass) is near open.

The right picture is a scope trace of the C401 waveform when the capacitor is open.



# Reports from the test lab

By Carl Babcoke

---

*These monthly reports about electronic test equipment are based on actual examination and operation in the ELECTRONIC SERVICING laboratory. Observations about the performance, and details of new and useful features are spotlighted, along with tips about how to use the instruments for best results.*

---

Some of the major features of the Heath Model SO-4510 (IO-4510 in kits) lab-type scope are:

- all solid state, except for the CRT;
- dual-trace, single-trace, or X/Y operation;
- excellent brightness and sharpness of the traces;
- a delay line to prevent cutoff of the first parts of waveforms;
- triggered horizontal sweep up to .1-microsecond-per-centimeter (shows only four cycles of 3.58-MHz signal); and
- 1-millivolt-per-centimeter vertical sensitivity at 15-MHz response.

## Vertical Amplifiers

Three important characteristics of the vertical amplifier stages of any scope are rise time (related to frequency response), gain and stability. In the Heath SO-4510, these are excellent; as good as or better than other scopes checked in our lab.

Specifications are for maximum gain of only 1-millivolt-per-centimeter (each graticule square is 1 centimeter), rise time of 24 nanoseconds, and frequency response up to 15 MHz at -3 dB.

The 84-page operating manual gives some precautions for using a scope of this sensitivity. Moderate

care should be used to avoid problems of RF pickup or hum when the most-sensitive ranges are employed.

Even when a low-capacitance (X10 loss) probe is used, the sensitivity is .01-volts-PP-per-centimeter. This is more than adequate for any normal servicing requirement.

Of course, for dual-trace operation, two identical vertical channels are required up to the switching point. These channels can be operated in the X/Y mode when needed for vector patterns, etc.

The VOLTS/CM switch provides 12 ranges of vertical sensitivity, from 1 millivolt/CM with X1 probe to 50 V/CM with X10 probe. Thus waveforms up to 300 volts PP can be measured directly. Higher voltages can be read by use of the variable gain control (mounted concentrically). Calibration of the ranges is correct when the gain control is turned fully clockwise.

## Dual-trace operation

Clockwise rotation from OFF of either the Y1 POSITION control or the Y2 POSITION control provides single-trace operation of that one channel. When both are on, the switches select dual-trace operation.

Chopped or alternate-trace presentation of the two traces is selected automatically by the posi-

tion of the TIME/CM switch. In this way, visual disturbances from the time-sharing operation are minimized.

## Frequency response

Figure 1 shows AC-coupled 20-Hz square waves without the usual tilt. That's proof of excellent low-frequency response. In fact, the tilt was less than that observed on other scopes we have tested.

Waveshape of 200-KHz square waves was very good, far exceeding the response of the square-wave generator (Figure 2).

Composite video also was reproduced with excellent bandwidth, as well as good brightness and sharpness of the trace (Figure 3).

## Delay line

Because this is the first scope with a delay line that we have reviewed, the reason for having a time delay should be explained.

Scopes without a delay circuit trigger at the preset polarity and amplitude of voltage, but the part of the waveform doing the triggering is not seen on the screen (Figure 4). The sweep operates **after** the triggering point.

If it's desirable for the triggering point to be seen, a sample of the waveform is used (without any time delay) to trigger the horizontal



# Replace 427 color picture tubes with only 74 RCA types.

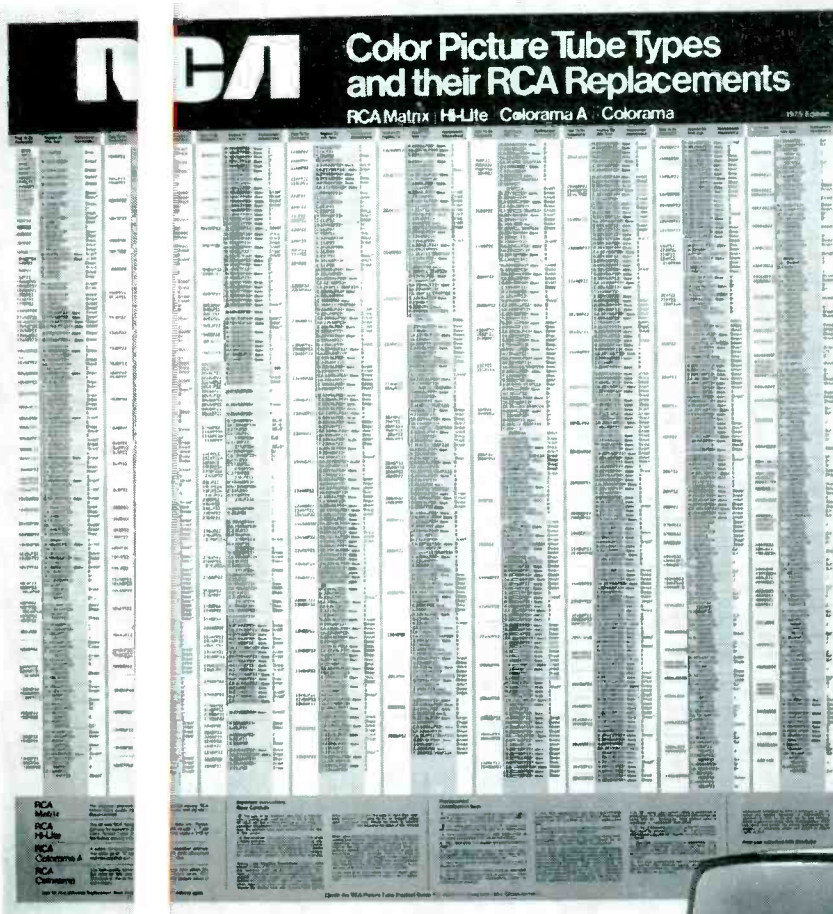

Find the correct color picture tube replacement quickly and easily with RCA's new 1975 Color Picture Tube Replacement Wall Chart, available now from your RCA Tube Distributor. You'll find that only 74 RCA types will replace 427 industry types.

The chart covers all three RCA color replacement lines — Hi-Lite, Colorama A and Colorama. In the Hi-Lite line of all-new premium replacements, just 3 "V" types — 23VAL, 19VAB and 18VAH — will replace 213 of today's best-selling industry types.

The chart also shows RCA Matrix types available in all three lines. These advanced RCA tubes have as much as twice the brightness of any equivalent non-Matrix tube.

See your RCA Distributor and ask for the 1975 RCA Color Picture Tube Replacement Wall Chart (1D1548) where one quick glance tells you the right replacement. And remember,

**RCA is the world-wide leader in picture tubes with over 65 million produced to date.**

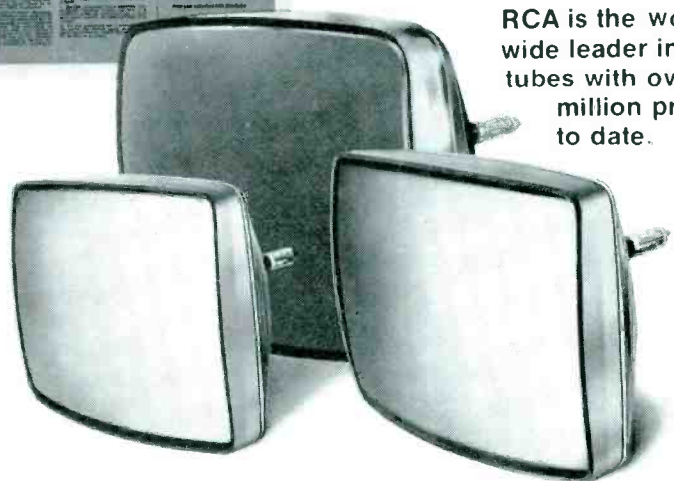

RCA | Distributor and Special Products Division | Cherry Hill, New Jersey 08034

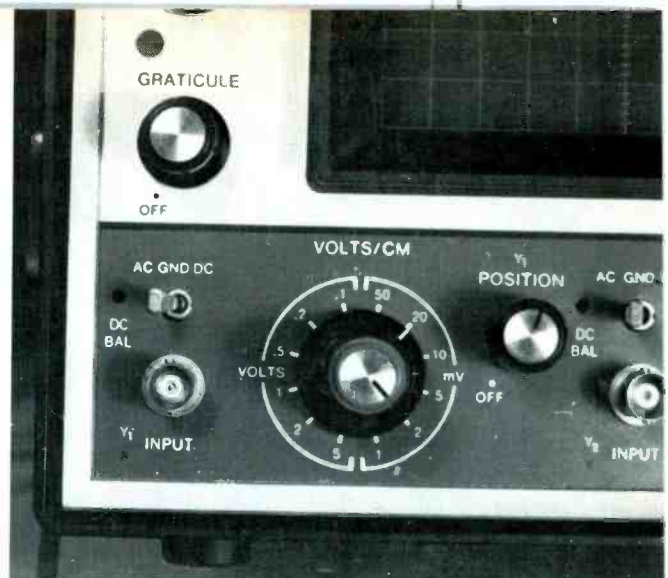
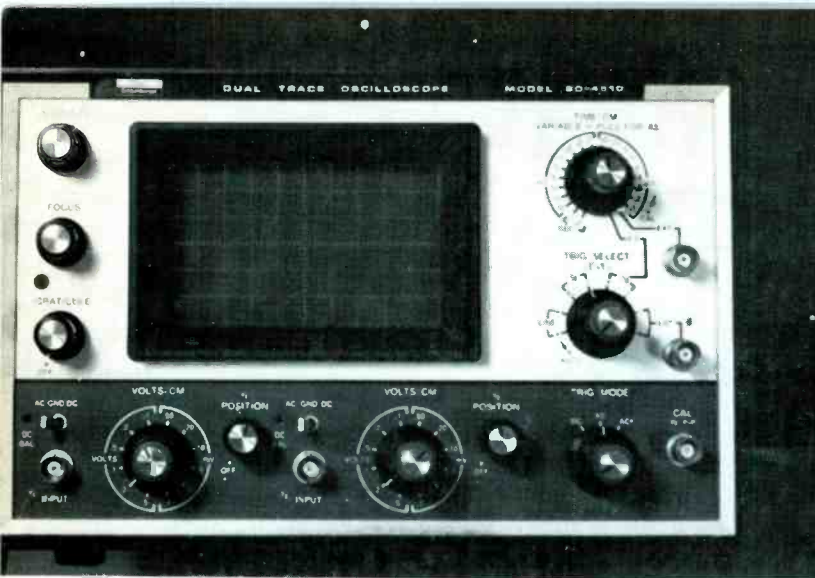

sweep, while the signal of the vertical amplifier is delayed in time so it arrives at the CRT screen 20 nanoseconds later than usual.

Although the visible signal is delayed, and the sweep is unchanged, the appearance of the waveshape on the screen makes it appear that the sweep starts sooner than usual.

### Horizontal Sweep

Of course, the horizontal deflection is triggered-sweep type, with all of the advantages that brings. Twenty ranges are supplied by the TIME/CM switch, plus an infinite range of in-between times by adjustment of the concentric VARIABLE control. The calibration is correct when the control is turned completely clockwise.

The seconds, milliseconds, and microseconds ratings of the TIME/CM switch refers to the amount of time necessary for the scanning beam to travel the one centimeter from one horizontal graticule mark to the next. Therefore, when the .2-second range is selected, the beam takes 2 seconds to travel the full 10-centimeter width of the screen. At .1 microsecond, only four cycles of 3.58 MHz are shown (Figure 5).

In addition, the X5 function is activated by outward movement of the VARIABLE knob. Although the action makes the visible part of the trace five times wider, it gives the same effect as sweep that is five times as fast. In other words, the .5

MS range becomes .1 MS, and the .1 microsecond range becomes .02 microseconds. This is a very useful function, although the trace becomes more dim, as it does in all scopes.

The 21st position of the TIME/CM switch disconnects the timed sweep, allowing horizontal sweep to come from a signal applied to the EXT jack.

An exceptionally-broad range of triggering options is possible by operation of the TRIG SELECT switch. For example, triggering can be of either positive or negative polarity from the 60-Hz line, Y1 channel, Y2 channel, or an external signal through the EXT jack. No internal sync separator for composite video signals is incorporated. However, a sample of TV vertical or horizontal sweep (depending on the need for field or line examination) applied to the EXT trigger jack can give rock-steady video waveforms. This method is highly recommended.

Operation of the concentric LEVEL control in the AUTO (fully counterclockwise) position gives automatic triggering at the zero-crossing line of the waveform, and it also provides horizontal sweep even without a signal in the vertical amplifier.

When it is rotated clockwise, the LEVEL control operates as a conventional locking control. Position of the control determines the exact point of the waveform where triggering takes place.

### CRT Controls

Three controls for the CRT are located to the left of the screen. They are INTENSITY, FOCUS, and GRATICULE illumination.

The CRT is a Spiral PDA (Post Deflection Acceleration) type, with 1 KV applied to the gun elements and 3 KV to the anode. This total of 4 KV no doubt accounts for the high brightness and sharp focus of the waveforms.

These voltages are regulated, permitting the use of high brightness with very little blooming of the waveform size or change of focus.

### Other Features

A rotary switch under the main chassis adapts the scope to any of six line voltages from 110 to 250 volts RMS.

BNC-type jacks are used for all probes and cables.

All inputs are protected against over-voltage by double-diode clippers.

A 1-volt-PP square-wave signal for sensitivity calibration tests is available from the CAL jack located at the lower right corner.

### Summary

The designers of the Heath SO-4510 scope have done an outstanding job of providing first-rate performance while minimizing the number of controls and adjustments. The scope should be very satisfactory for all radio/audio/TV repairs, and most laboratory applications. □

layout of the front panel is logical and handy. The old-state, dual-trace SO-510 Heath lab scope controls are to the left of the screen, with horizontal-sweep controls on the right. All controls and jacks for the twin vertical channels are along the bottom in the dark-blue area.

(far left) is on the model SO-510 Heath lab scope screen, with horizontal-sweep controls on the right. All controls and jacks for the twin vertical channels are along the bottom in the dark-blue area.

A toggle-type AC/DC coupling switch is used, with a GND (ground) position in the center. This center position is very useful for giving a dc-signal without the bother of disconnecting the test probe.

coupling switch is used, with a GND (ground) position in the center. This center position is very useful for giving a dc-signal without the bother of disconnecting the test probe.

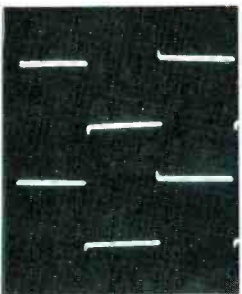

Fig. 1 Trace at the top shows a 20-Hz square-wave signal with AC input coupling (a capacitor series). Most scopes have a noticeable tilt, proving some loss of low-frequency response. The waveform at the bottom is the same signal with DC coupling.

shows a 20-Hz square-wave signal with AC input coupling (a capacitor series). Most scopes have a noticeable tilt, proving some loss of low-frequency response. The waveform at the bottom is the same signal with DC coupling.

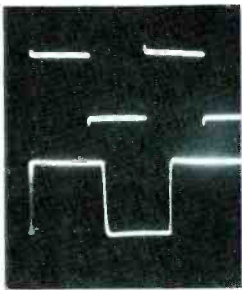

Fig. 2 20-Hz (top) and 200-KHZ (bottom) waveforms show excellent bandwidth of the scope, without ringing or overshoot.

and 200-KHZ (bottom) waveforms show excellent bandwidth of the scope, without ringing or overshoot.

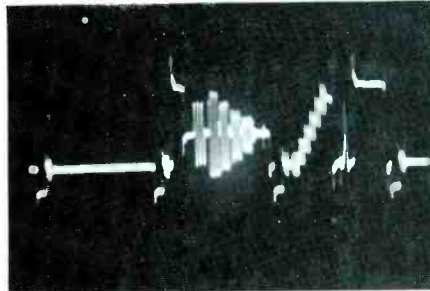
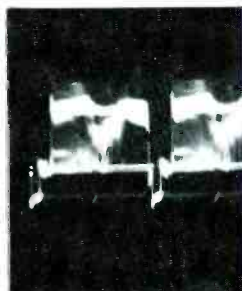

Fig. 3 Composite-video and VITS waveforms were very sharp and quite bright.

and VITS waveforms were very sharp and quite bright.

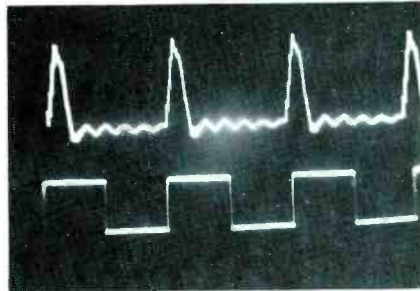
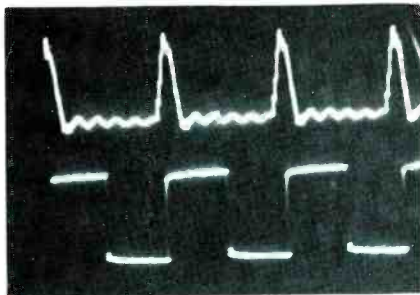
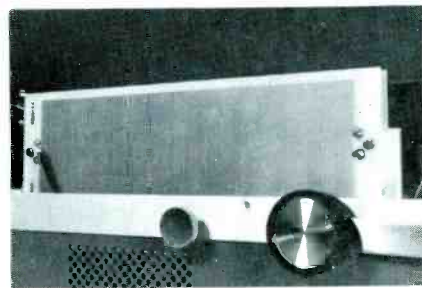

Fig. 4 Normal triggered-sweep operation does not permit the triggering point of the waveform (top picture of horizontal-sweep pulses and 15,000-Hz square waves) to be seen on the screen. The Heath SO-4510 has a 20-nanosecond delay line in the vertical amplifier, so the triggering point arrives at the screen after the sweep has started (bottom picture). This is a useful feature for some applications.



Physically, the delay line appears to be a double RF choke on PC boards.

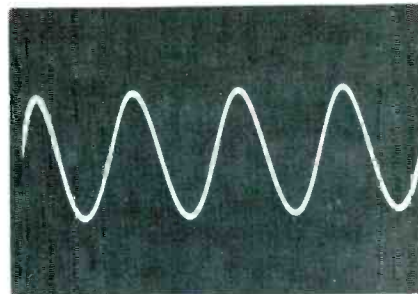
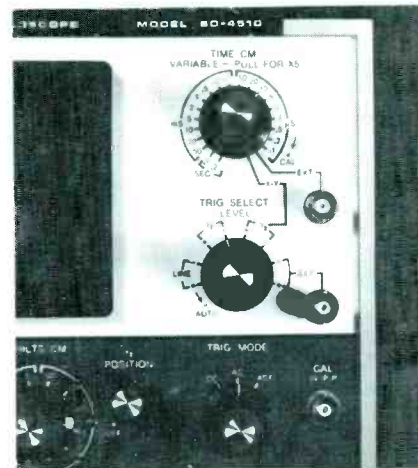
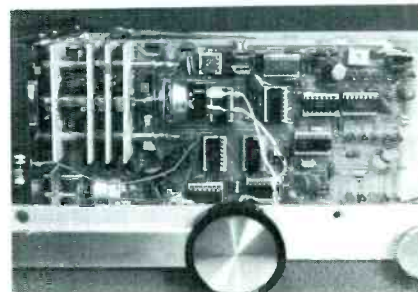

Fig. 5 The .1-microsecond sweep range permits viewing only 4 cycles of a 3.58-MHz color-oscillator carrier. With the X5 feature, less than one complete cycle would show. That's very good performance.



Panel markings clearly show which jacks connect to which switches. The TIME/CM switch selects sweep times per centimeter of .2 second to .1 microsecond, while the VARIABLE control can slow the speed as much as three times. The control allows you to obtain the exact number of cycles desired. Pull out on the VARIABLE control for 5X increase of width. Source and polarity of the triggering signal are selected by the TRIG SELECT switch. Concentric with it is the variable LEVEL control for determining the voltage at which triggering occurs. Just below is the TRIG MODE switch that gives best locking of DC, low-frequency AC, or high-frequency AC signals.



This view shows the neat wiring, and some of the many IC's used.

# test equipment report

These features supplied by the manufacturers are listed at no-charge to them as a service to our readers. If you want factory bulletins, circle the corresponding number on the Reply Card and mail it to us.

## Pocket-Sized FET Multimeter

Automatic polarity selection with an indicator light, and 10-megohm input impedance for both DC and AC ranges are two important features of the **Hickok Model 350** FET multimeter. Other features include: nine AC and nine DC voltage ranges from .1 to 1000 volts full scale; nine decibel ranges from -20 to +60 dB; seven ohmmeter ranges from 100 ohms to 100 megohms center scale (with switch-selectable high-voltage or low-voltage operation); mirrored meter scale, meter-overload protection; and approximately one-year operation on the two internal 9-volt batteries.

The Hickok Model 350 multimeter has a durable polypropylene case with attached cover, and comes with two test leads and an instruction manual.

For More Details Circle (50) on Reply Card

## Function Generator

A new function generator combining wide frequency range, compact size, and low-cost, is offered by the **Heath Company**. The instrument gen-



erates sine, square, or triangle waveforms from 0.1 Hz to 1MHz. A short-circuit-proof output amplifier supplies a 10-volt peak-to-peak signal into a 50-ohm load. Calibrated step attenuator adjusts from 0- to 50-dB in 10-dB steps. Variable attenuator control gives up to 20-dB additional attenuation for each step for a total of 70-dB.

The kit version, IG-1271 is \$99.95; assembled version retails for \$140.00.

For More Details Circle (51) on Reply Card

## Dual-Channel Oscilloscope

Featuring a built-in delay line to make visible the leading edge of traces, Model 1222A from **Hewlett-Packard** is priced at \$895.00. The 15-MHz dual-channel oscilloscope gives the technician the option of viewing Channel A with Channel B either added or subtracted ( $A \pm B$  modes). Identical dual channels provide calibrated X/Y displays.

In common with higher-priced scopes, Model 1222A has 3% vertical accuracy, calibrated 8X10 CM display, internal graticule to help eliminate parallax, DC coupling, triggered sweep, and pushbutton beam-finder. Deflection factor is adjustable from a sensitive 2 mV/cm to 10 V/cm, so the instrument is useful for logic, control, audio and video measurements, as

well as low-level uses such as receiver tests.

Built-in TV sync separation helps to assure stable, automatic triggering on

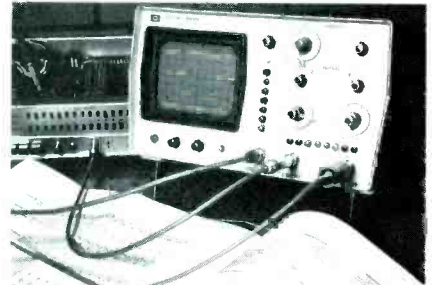

frame or line for convenient TV troubleshooting. Calibrated sweep, accurate within 4%, simplifies diagnosing timing problems.

For More Details Circle (52) on Reply Card

## AC Voltmeter/Amplifier

Model 3056A is the latest addition to **Ballantine Laboratories'** line of AC analog instruments. The broadband, wide dynamic range voltmeter/amplifier features a 5-Hz to 10-MHz frequency range and full scale ranges of 100 microvolts to 1 kilovolt in eight 20-dB steps. The total dB range is 150 dB.

When used for amplifier-gain measurements, the front-panel continuously-variable Relative-Reference control allows setting the meter at a convenient reference point at the start of a measurement. A built-in 100-KHz low-pass filter makes possible accurate measurements when reading low frequency signals in the presence of high-frequency noise.

As a stable AC amplifier, Model 3056A provides a maximum voltage gain of 80 dB from approximately 10 Hz to 10 MHz. An optional internal NiCd rechargeable battery pack provides off-line operation and field portability.



The instrument is average responding (not peak reading), and has linear dB scales plus logarithmic calibrations for AC voltage.

For More Details Circle (53) on Reply Card

## Portable CRT Analyzer, Rejuvenator

Model 265 CRT analyzer/rejuvenator from **Hickok** is capable of testing and rejuvenating all b/w or color TV picture tubes, including new in-line types. Designed with simplified meter scales and controls for fast but thorough testing, the tester comes complete with 13 individual socket assemblies.



Lightweight and portable, Model 265 features a unique filament-protection circuit to help prevent accidental CRT filament burn-outs. Solid-state circuitry with glass-epoxy PC boards is said to assure long service life.

Easy set-up of G1 and automatic set-up of G2 helps reduce lost time. A single 10-position function switch controls shorts, opens, emissions, and tracking tests as well as the 3 rejuvenating levels.

The product costs \$205.00 and includes a comprehensive CRT troubleshooting chart. □

For More Details Circle (54) on Reply Card

# Bookreview

**Linear IC Principles, Experiments, and Projects**  
 Author: Edward M. Noll  
 Publisher: Howard W. Sams & Co., Inc. 4300  
 West 62nd Street, Indianapolis, Indiana 46268  
 Size: 383 pages, book number 21019  
 Price: \$8.95 paperback  
 Written to introduce the principles of integrated-circuit operation, Noll's book begins with a review of semiconductor theory and practical applications. Formation of various active and passive components are covered, as well as common internal circuit arrangements and the basic external circuitry needed to perform a specific electronic function. Considerable emphasis is placed on differential and operational amplifiers which are fundamental to IC devices. Important multipurpose ICs and special systems are discussed in detail. A set of five experiments are included for those who like the learn-by-doing approach. The last four chapters explain how linear ICs are used in test equipment and commercial and industrial applications. Home-entertainment audio, AM/FM, and TV applications are discussed.

**Practical Circuit Design for the Experimenter**  
 Author: Don Tuite  
 Publisher: TAB Books, Blue Ridge Summit, Pennsylvania 17214  
 Size: 196 pages, 119 illustrations, book number 726  
 Price: \$8.95 hardbound, \$4.95 paperback  
 Written for the technician interested in a more analytical approach than can be found in most books, this text includes a quick review of the basics, then proceeds to cover material usually presented only in a 4-year engineering curriculum. To understand the engineer's tools of analysis and design presented by Don Tuite, the reader needs a fundamental ability to work with algebra, beginning with Kirchhoff's laws, and electronics design are presented from a practical point of view so they can be clearly understood and applied to complex impedances and parameters. Understanding complex and phase relationships is easier after a chapter on trigonometry and some "exotic" algebra. A chapter on the Laplace transform stresses a realistic application of the transform in solving circuit problems. Image-parameter filter design is covered, complete with design formulas, diagrams, and illustrative examples. A number of problems illustrate transmission-line behavior by means of Smith charts. Active and passive nonlinear devices are explained from a characteristic and load perspective, with the behavior of ideal components and amplifier models.

# Measure 100 $\mu$ V to 40 kV ...for less than \$200!

Now it's possible to get just about all the voltage measurement capability you'll ever need. With these new instruments from Heath — The IM-2202 Portable Digital Multimeter and the IM-5210 High Voltage Probe Meter — you can have DC voltage measurement capability over a 166 dB dynamic range, for a total cost of only \$197.90\* for both instruments.



The lowest priced professional-grade DMM we've ever offered...

only \$179.95\*

Designed for field or bench, the portable IM-2202 will provide years of dependable measurement for the professional serviceman. Four rechargeable nickel-cadmium batteries (included) provide up to eight hours of continuous operation. Or it may be operated from 110/220 VAC when continuous operation is necessary. Full scale ranges are 100 mV (with 100  $\mu$ V resolution!) to 1000 volts DC, 100 mV to 750 volts AC, 100  $\mu$ A to 1000 mA and 100 ohms to 1000 kilohms. The 100% overrange allows measurement to 1.999 on all ranges except 1000 VDC and 750 VAC, giving full 2 amp or 2 megohm capability. All voltage ranges have high input impedance to prevent circuit loading. Internal standards allow calibration to 0.5% for DC and 1% for AC or, with a lab standard, 0.2% for DC and 0.5% for AC. Readout is a large, 3 1/2-digit display with automatic polarity indication and decimal point placement. Operation couldn't be simpler — a Range switch and four pushbutton Function switches select any of the measurement ranges. Easy operation, high accuracy and dependable performance...you get them all with the Heathkit IM-2202. Available in kit-form only, \$179.95\*.

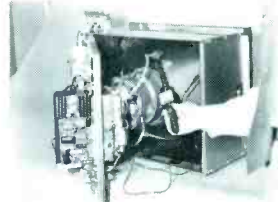

New Heathkit probe meter measures TV tube voltages to 40 kV...

only \$179.95\*

TV tube voltage measurements are fast and easy with the IM-5210 Probe Meter. You just attach the ground clip to the TV chassis, place the probe tip against the tube's high voltage connector and switch on the meter. It's an easy kit to build, taking about an hour to assemble. With a kit-form price of \$179.95\*, it's just about the best high voltage measurement value on the market. Also available assembled, only \$249.95\*.



## Send for your free Heath catalogs

The latest Heath/Schlumberger Assembled Instruments Catalog features a complete line of high performance, low cost instruments for service and design applications. Our '75 Heathkit Catalog describes the world's largest selection of electronic kits — including a full line of lab and service instruments. Send for your free copies today.

HEATH COMPANY Dept. 25-05 Benton Harbor, Michigan 49022		HEATH <b>Schlumberger</b>
<input type="checkbox"/> Please send the 1975 Heathkit Catalog.		
<input type="checkbox"/> Please send the latest Heath/Schlumberger Assembled Instruments Catalog.		
Name _____		
Title _____		
Company/Institution _____		
Street _____		
City _____ State _____ Zip _____		
*MAIL ORDER PRICES; F.O.B. FACTORY. PRICES & SPECIFICATIONS SUBJECT TO CHANGE WITHOUT NOTICE.		
		TE-315

# productreport

These features supplied by the manufacturers are listed at no-charge to them as a service to our readers. If you want factory bulletins, circle the corresponding number on the Reply Card and mail it to us.

## Pegboard Parts Jars

**Brookstone Company** offers removable containers that attach by their covers to standard 1/8-inch pegboard. See-through, unbreakable plastic containers release with a quick quarter-turn. Simple, more convenient, and neat, a package of 10 containers costs \$4.40.

For More Details Circle (55) on Reply Card

## Integrated-Circuit Tool

Insert or extract integrated circuits easily with the Pul-N-Sertic tool from **GC Electronics**. Said to provide maximum protection to IC leads, the tool also acts as a heat sink when desoldering ICs.

Pul-N-Sertic, catalog no. 9481, is made of rugged, high-impact plastic.

For More Details Circle (56) on Reply Card

## Radio-Pager

Metro-Pageboy binary digital radio-pager is said to be the smallest high-speed city-wide pager available. **Motorola** reports 100,000 pagers on a single system terminal are possible.

A shock-isolation system reduces possibility of damage to the radio if dropped. A dual-function feature allows the user to receive two different alert tones, each indicating a specific location for a return call.



Another feature, Mem-O-Lert, stores all incoming pages when the user does not want to be disturbed.

For More Details Circle (57) on Reply Card

## Portable Fire Extinguisher

A compact, lightweight fire extinguisher from **General Electric** features push-button action and all-weather reliability. According to the manufacturer, the non-toxic, dry chemical powder is odorless and will not conduct electricity.

For More Details Circle (58) on Reply Card

## Smoke Alarms

Two smoke alarms from **Mallory Distributor Products** have been designed for easy installation in homes and businesses.

The battery-powered model, SDA-3, is engineered to trigger the smoke alarm when the battery becomes weak, thus calling attention to the need for a replacement battery. The alarm is priced at \$81.00, battery included.

Model SDA-2 operates from standard electrical current and has a built-in pilot light to indicate it is functioning. The alarm is priced at \$61.60.

For More Details Circle (59) on Reply Card

## Battery-Operated Security System

**Radio Shack's** Realistic Powerhorn-3 security system features fail-safe battery operation and easy installa-

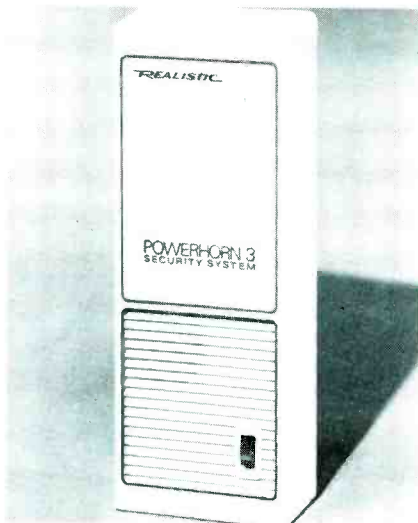

tion. Magnetic contact switches or foil strips can be used to protect any number of doors and windows. The alarm sounds even if the wires are cut before entry.

Two alarm functions are provided: one sounds the built-in alarm; the other has a 15-second delay, which allows you to leave or re-enter without setting off the alarm.

The Powerhorn-3 system with magnetic contact switch and wire is priced at \$19.95. Additional contact switches and window foil strips are available.

For More Details Circle (60) on Reply Card

## Focussed Heat Source

A source of 260° hot air that is restricted to a small area by an extension tube is provided by the **Wahl Clipper Corporation** Thermal Spot Tester. The product is a small

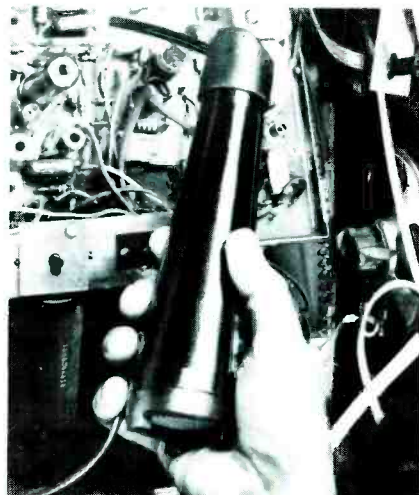

heater with a blower and flexible extension tube for warming individual capacitors and transistors that do not malfunction until they are heated. This method is said to be faster and more economical than warming the entire TV set and then chilling individual components. Also, Thermal Spot can dry tuners after cleaning, and cure epoxies.

For More Details Circle (61) on Reply Card

## Cordless Soldering Iron

Suitable for intricate to heavy-duty soldering, the cordless soldering iron from **Weller-Xcelite** provides instant heat to 700°F. Portable and self-contained, the iron comes with 3 interchangeable tips.

A heat-resistant handle holds a nicad battery unit that gives 15 minutes of constant tip temperature. Rechargeable overnight, the battery unit has an average life of 500 chargings.

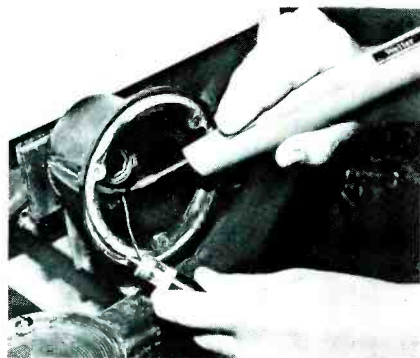

The product is contoured and balanced for hand comfort. A fail-safe lock helps to insure against accidental triggering.

For More Details Circle (62) on Reply Card

(Continued on page 48)

# SERVICE ASSOCIATIONS

Electronics Inc. announce Conference to Place, 1500 C Theme of the Service '75", a Customers To Cann, Jr. is pr Director of EI

The Midwes CET's at a me officers were Secretary-Trea: tor of Educatio March 21, Kansas City t they are askin Perry was elec Chairman, and

A conventio June 7 and 8 by members of

National EI (NESDA) has developed these

Repairs made home  
Major repairs 67%  
Repairs made shop  
Symptoms miszen for burning  
Replacement c picture tube  
Replacement c AC cable  
Non-TV work- % of total  
\*These figure probably account for the erroneous government es

National All Associations ( of letters with ing the concl of service firr and San Franc that 9 new receivers each lator tube wer model was AI horizontal osc that a horiz defect, becaus other tubes or circuits.

## ETA of La. News

chnicians Association of Louisiana, plans for the 12th Annual Service held July 18-19-20, 1975 at Braniff al Street, New Orleans, Louisiana. de show is "Update Test Gear For the theme of the seminars is "Tune inimum Distortion". Malcolm Mc- dent and Roger Drost is Executive of La.

## Midwest IS CET News

hapter of IS CET was formed by 14 ng in Kansas City March 17. These lected: Chairman, Jerry Recob; er, Don Houghton; and Administra- Henry Golden.

elve shop owners organized the nsumer Electronic Specialists, and for affiliation with NESDA. David l Chairman, Lyle Blakeley is Vice- Henry Golden is Secretary-Treasurer.

## KEA News

and test-equipment fair will be held the Diamond Inn, Wichita, Kansas ie Kansas Electronic Association.

## NESDA News

ronic Service Dealers Association (NESDA) has ained data from four states and has tistics about repairs:

	COLOR TV	B&W TV
Repairs made home	47%	30%
Major repairs	67%	61%
Repairs made shop	53%	70%
Symptoms miszen for burning	24%*	24%*
Replacement c picture tube	3%	3%
Replacement c AC cable	3%	5%

\*These figure probably account for the erroneous government es

## NATESA News

nce of Television & Electronic Service TESA) has engaged in an exchange e Federal Trade Commission regard- ons reached from FTC investigations in Washington, DC, New Orleans, o. First reports from the FTC stated d "perfect" RCA Model AH151 th a burned-out 8FQ7 vertical oscil- sed. Later it was learned the correct l (about 1973) and the tube was a ator. NATESA correctly pointed out al oscillator was a poor choice of ome modes of failure would damage omponents in the deflection and HV

# the bright one

new phosphor picture tube  
with twice the brightness

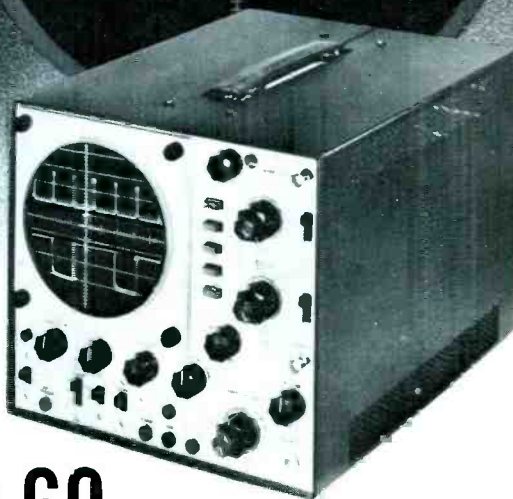
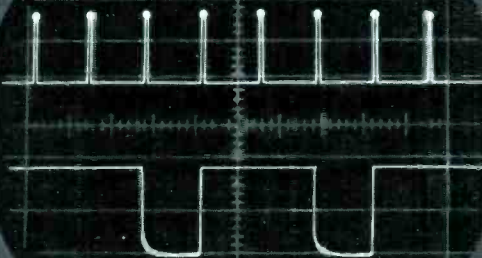

## TO-60 automatic dual-trace triggered-sweep oscilloscope

P-31 phosphor CRT has double the brightness for bright displays even in high speed dual-trace modes. Bandwidth: DC to 15 mhz. Unique features for the industry's greatest value are: • Automatic Triggering • Automatic Astigmatism • Automatic Horizontal Sweep • Automatic Horiz/Vert. TV Triggering provides positive display on composite video signals. Vertical sensitivity: .01 volts/cm to 20 volts/cm in 1-2-5 step sequence. Horizontal Sweep Speeds: .2 sec/cm to .5µ sec/cm in 1-2-5 step sequence. Has 5X magnifier at all sweep speeds. External Horiz. Amp. Bandwidth: DC to .5 mhz; Sensitivity: .5 volts/cm. Calibrated Test Signal: 1 volt P-P square wave. Power: 105-125 volts, 60 cycles, 65 watts

Model TO-60 Less Probes. Net . . . . . \$489.50

TO-55 automatic single-trace triggered sweep oscilloscope. Features same as TO-60 except Vert. Bandwidth is DC to 10 mhz.

Model TO-55 Less Probes. Net . . . . . \$379.50

For the "bright one," see your distributor, or write:



**LECTROTECH, INC.**

5810 N. Western Avenue, Chicago, Illinois 60659  
Area (312) 769-6262

For More Details Circle (26) on Reply Card

# More chances to be right



Thousands more cross references



Transistor kit for foreign sets



Replacement amplifier modules



All the help you need at your authorized distributor

Tube Products Department  
General Electric Company  
Owensboro, Kentucky 42301

**GENERAL ELECTRIC**

## productreport

(Continued from page 46)

### Telephone "Hold" Circuit

Designed for any single-line home or business telephone, Tele-Hold allows you to hang up your phone and have a private discussion, or move to an extension without disconnecting your party.

Manufactured by **Phone Crafters**, the device is priced at \$19.95.

For More Details Circle (63) on Reply Card

### Replacement TV Delay Lines

A new series of replacement TV delay lines has been introduced by J.W. Miller Division of **Bell Industries**. The series consists of 15

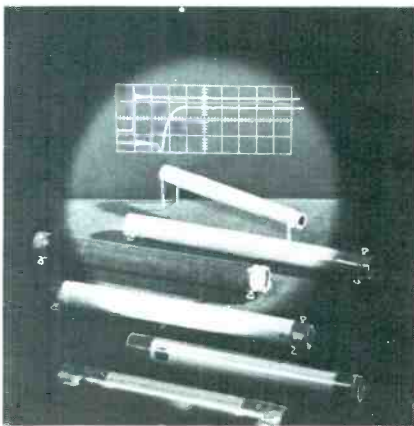

delay lines designed as replacements for more than 500 OEM part numbers used in virtually all brands of color TVs.

For More Details Circle (64) on Reply Card

### Cone-Shaped Cutting Tool

The "Conecut" tool reportedly drills large holes of any diameter more smoothly and quickly than by any other means available. When used in a hand-held electric drill, the tool can drill thin sheet metal without requiring a pilot hole or punch mark, even when surfaces are curved or tubular.

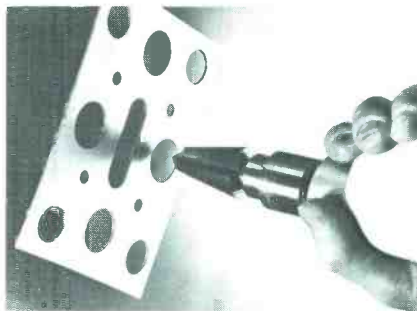

A high-speed steel cone with two flutes, a drill point, and a 3/8-inch shank, the "Conecut" is available in three sizes for drilling burr-free holes from 1/4-inch to 2 1/16-inch. Number

4 follow-on tool with 1/2-inch shank is available also from **G. and J. Hall Ltd.**

For More Details Circle (65) on Reply Card

### Over-Voltage Protection Device

A solid-state device to protect home entertainment equipment against potentially-damaging voltage transients has been introduced by **General Electric's Tube Products Department**.

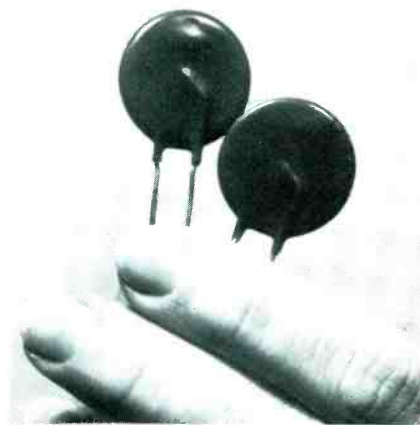

The device, GE-MOV®, is a metal-oxide varistor which responds to voltage transients in 50 billionths of a second, absorbs them, and dissipates them as heat. The action is similar to that of zener diodes; excess voltages are clipped by sudden conduction.

Connected across the AC power circuit of a TV, stereo, or tape system, GE-750 will help protect against voltage spikes, line surges following a power outage, voltage surges caused by motors starting, oil burners, or fluorescent lighting, and many minor lightning-created surges.

For More Details Circle (66) on Reply Card

### Home Security Systems

**Master Lock** has formed a new Alarm Products Division which offers home security systems for fire and burglary protection at a reasonable cost.

Centralarm, a solid-state control center, permits choice of installation with fast snap-on wire connectors, the standard concealed-hardware method, line-carrier transmission, or any combination of systems for flexibility and fast, easy installation.

Ultrason Alarm is an ultrasonic motion detector, which turns on lights after detection of any movement in the protected area. Then, 30 seconds later, it sounds a loud satellite alarm. No wiring is needed.

Home Alarm Sets offer easy, snap-on installation. Each set includes both intrusion and fire detectors. An electronic siren sets off a pulsating signal to warn of burglary, and a steady signal to warn of fire. □

For More Details Circle (67) on Reply Card



# antenna systems report

These features supplied by the manufacturers are listed to them as a service to our readers. If you want factory buy prices, circle the corresponding number on the Reply Card and mail it to us.

## All-Channel TV Antenna

**JFD Electronics** has five new models of a new antenna called Colson. It has a straight-dipole loop antenna design that is said to give a sharp pattern for high gain and reduced ghosting. Cascaded HF drivers in a corner reflector improved reception on channels 14 through 83.

Prices of the models range from \$24.40 to \$90.

For More Details Circle (68) on Reply Card

## Crimping Tool

**Model 7188C Crimp-O-Matic** from **Finney Company** is a unique jaw design that helps eliminate the danger of crushed fittings. Crushed fittings are said to be a common cause of what degrades antenna systems using 75-ohm cable.

Jaws of the crimping tool close against each other at a point, giving proper crimping pressure on the signals in MATV without excessive force applied by the technician.

List price of Model 7188C Crimp-O-Matic is \$16.30.

For More Details Circle (69) on Reply Card

## VHF Single-Channel Pre-Strip Amplifier

**Model G-120** is designed to be placed between the download and a

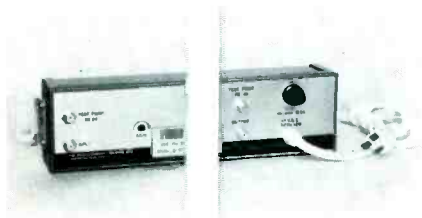

single-channel distribution amplifier to give the extra gain needed for weak signals. The VHF pre-strip amplifier from **Finney Company** has 30-dB gain output, and a low noise figure.

For More Details Circle (70) on Reply Card

## Audio Modulator For MATV

Developed by **Jerrold Electronics**, Model **ATS Audio-Trol** can be modulated by any radio signal of 50 mV or more (such as from a tape player, record changer, or microphone with a preamplifier for voice announcements), and the sound can be reproduced by any TV tuning in the Audio-Trol channel on a CATV or MATV system.



This solid-state audio modulator generates a complete TV channel, including an FM audio carrier and a picture carrier without modulation. Audio-Trols are available for all VHF channels.

Output signal is 53 dBmV for each carrier, and modulation distortion reportedly is less than 2%. Input impedance for the audio is 600 ohms unbalanced, and the RF terminals are for 75 ohms impedance.

The Audio-Trol is expected to be used in hospitals, motels, and apartment buildings where background music, news, radio programs, or voice announcements can be heard anywhere a TV set is tuned to the MATV special channel.

For More Details Circle (71) on Reply Card

## Mixing Dividing Networks

**Delta-Benco-Cascade** has designed mixing dividing networks to combine several single-antenna outputs into one common down lead. There are three 75-ohm units: the MDN-7 combines or divides three low and four high channels; the MDN-LO for three low channels; and the MDN-HI for four high channels.

The system incorporates two-stage, bandpass filters for each of the selected channels, which are coupled capacitively to the line. The MDN-7 is factory pre-aligned to these channels: 2-4-5-7-9-11-13.

MDN-7 is \$42.80, plus \$7.00 for non-standard alignment. □

For More Details Circle (72) on Reply Card

# SPRAY AWAY THE RACKET.



Squeak. Whine. Whirr. Pssst! Silence. Quietrol did it again. Silenced those moving T.V. parts, with one handy spray pack. Cleaned away dirt, dust, and crud. Without damaging anything... in any black and white or color set. Silence is golden. So is Quietrol.

Also available in bottles, and the new Silicone—"Silitron."



Product of  
**QUIETROL**  
COMPANY  
Spartanburg, South Carolina

For More Details Circle (18) on Reply Card

## APPLIANCE REPAIR BOOKS

Written in easy-to-understand language by experts with illustrations & diagrams. Acclaimed by instructors & professionals. How to diagnose & repair air conditioners, refrigerators, vacuum cleaners, ranges, washers, dryers, steam irons, portable kitchen appliances, water heaters; plus how to set up a shop, using test instruments and more. Only \$2.65 to \$4.90 each!

SEND FOR FREE DESCRIPTIVE PRICE LIST

C & N, DEPT. ES, 5841 MONTROSE, CHICAGO 60634

For More Details Circle (19) on Reply Card

## FREE CATALOG

### HARD-TO-FIND PRECISION TOOLS

Lists more than 2000 items—pliers, tweezers, wire strippers, vacuum systems, relay tools, optical equipment, tool kits and cases. Also includes ten pages of useful "Tool Tips" to aid in tool selection.

**JENSEN TOOLS**  
4117 N. 44th Street, Phoenix, Ariz. 85018

For More Details Circle (20) on Reply Card

## IT'S NO PUZZLE

TO ORDER

## OELRICH SERVICE FORMS

FOR TV-RADIO & 2 WAY RADIO SERVICE LEGAL FORMS FOR CALIF., FLA., UTAH NOW AT YOUR PARTS JOBBER OR WRITE FOR CATALOG B64

**OELRICH PUBLICATIONS**  
4040 N. NASHVILLE AVE. CHICAGO, ILLINOIS 60634

For More Details Circle (21) on Reply Card

What would you like  
to read in ES?  
Send in your ideas.

# audio systems report

These features supplied by the manufacturers are listed at no-charge to them as a service to our readers. If you want factory bulletins, circle the corresponding number on the Reply Card and mail it to us.

## Automatic Turntable

Featuring a new deep and heavy (4-pound) turntable platter and walnut-grained wood base, Model 620AX automatic turntable from **BSR-McDonald** also includes dual-range anti-skate, stylus-force adjustment, and viscous-damped pause and cue.

For More Details Circle (73) on Reply Card

## Audio Console

An eight-channel mixer-preamplifier that accepts up to eight low-impedance microphones, with two channels that can be switched to accept high-level inputs is the SR101 audio console from **Shure Brothers**.



SR 101

Each input features linear-action sliding gain control, high- and low-frequency equalization, and adjustable reverberation. The SR101 provides simultaneous program and monitor outputs, each controlled by individual master volume controls and has dual "link" jacks to help facilitate connection of an additional audio console, mixer or other external equipment.

The console can be rack-mounted. User net price is \$960.00.

For More Details Circle (74) on Reply Card

## Telephone Convenience Devices

Eico has developed a line of telephone products for home use, called "Foneaids". There are six models, ranging in price from \$19.95 to \$39.95.

Model FA-10 is a low-cost phone-answering device. After a pre-determined amount of time (from 3-10 minutes), Model FA-20 automatically beeps to remind you of overtime calls.

Model FA-30 indicates a ringing phone by a blinking red light or a pleasing oscillating tone. Call Monitor, Model FA-40, is an automatic recording switch that records all incoming and outgoing calls. An electronic combination phone lock that prevents unauthorized outgoing phone calls but does not interfere with incoming calls



is Model FA-50. Important calls can be transferred to another phone with Model FA-60, which is useful as a 3-way conference call connector to talk to two outside parties simultaneously.

For More Details Circle (75) on Reply Card

## Beer Barrel Speaker

The Schlitz beer-barrel speaker, from **Acoustech** is molded of high-density weatherproof polyurethane with realistic dark-oak woodgrain finish. The unit contains a two-way speaker system with a frequency response range of 50-18,000 Hz, and a volume control. The speakers come complete with an easy wall mount installation, and are priced at \$49.95.

For More Details Circle (76) on Reply Card

## High-Fidelity Loudspeaker

Twelve component speakers are featured in Monitor-C from **Bozak**. Four 8-inch wide-range speakers pro-

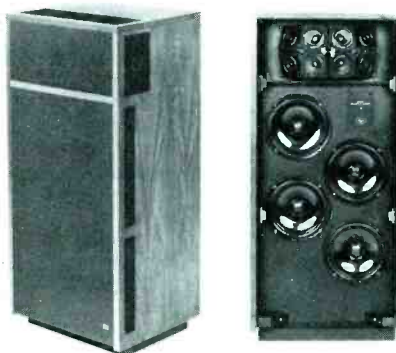

vide bass and mid-range tones. They are manufactured in a low-distortion design using rigid aluminum cones to prevent break-up. Eight treble speakers are arranged in a "sector-of-sphere" configuration for uniform response.

Bozak claims smooth frequency response over the 30-to-20,000 Hertz

range with minimal distortion.

Monitor-C has a power-handling capacity for 150 watts of program power, with a nominal impedance of 8 ohms.

For More Details Circle (77) on Reply Card

## Tele-Recorder

Tele-Recorder automatically keeps a permanent record of every telephone conversation. Self-contained and undetectable, the recorder reportedly does not interfere with phone operation.

Available from **Goodrich Products**, the unit is priced at \$57.95.

For More Details Circle (78) on Reply Card

## Solid-State Mixer-Preamplifiers

The **Bogen Division of Lear Siegler** has introduced two silicon-transistor, solid-state mixer-preamplifiers designed to add more inputs to a sound system without changing the existing amplifier.

The CAM and CM models feature four microphone inputs, a high-level auxiliary input, and separate volume controls for each input, plus a master volume control. The auxiliary can be used to connect a tuner, tape recorder, or record player.



Equipped with standard 1/4-inch phone jacks, the CM is for high-impedance microphones; the CAM has professional, three-conductor receptacles, each with a switch to select either high- or low-impedance, balanced or unbalanced inputs.

Both models provide a choice of high- or low-impedance microphone level outputs, as well as a separate high-level, high-impedance output. This output can be used to drive a booster amplifier or tape recorder requiring .5 to 2-volts, or to feed into the auxiliary input of an amplifier or preamplifier. Completely isolated from each other, the outputs can be used simultaneously.

Each unit can be battery-operated for portability. For tamper-proof operation or storage, either model can be wall-mounted in the WMK-1 flush-mounting steel cabinet, which has a tilt-open locking door that can be locked in the open or closed position.

For More Details Circle (79) on Reply Card

# photofact<sup>TM</sup>bulletin

PHOTOFACT BULLETIN lists new PHOTOFACT coverage issued during the last month for new TV chassis.

<b>BRADFORD</b> 1105D35/E15/E .....	1467-1
<b>GENERAL ELECTRIC</b> Chassis 19QB .....	1471-1
<b>JC PENNEY</b> 2875A, 2876A, 2877A, 2878A .....	1472-1
<b>JVC</b> 3240 .....	1472-2
3100D, 3100R .....	1466-1
3020 .....	1468-1
<b>K MART</b> SKC1970 .....	1470-1
<b>MAGNAVOX</b> Chassis T995-0 .....	1469-1
<b>PHILCO-FORD</b> Chassis 4BS40, 4BS40/C, 4BS40TS .....	1470-2
<b>RCA</b> Chassis CTC70, CTC76A/C/E .....	1468-2

<b>SANYO</b> 91T49 .....	1470-3
Chassis VE-55S00/-57S00/-59S00 .....	1474-1
21T57 .....	1476-2
<b>SEARS</b> 528.4174/4400/4474/4475 (Series) .....	1474-2
528.41881200 thru 528.41881210 .....	1445-3
562.50410300, 562.51160300, 562.51350300 .....	1448-3
562.50211400 .....	1475-2
<b>SONY</b> TV-115 .....	1446-3
<b>SYLVANIA</b> Chassis A19-1/-2, A22-1 .....	1473-3
<b>QUASAR/MOTOROLA</b> Chassis 16TS-929, 17TS-929, 18TS-929, 19TS-929 (Series) .....	1476-1
<b>WARDS AIRLINE</b> GAI-11115A/15B/55A/55B, GAI-11245A/45B/65A/65B .....	1475-3

## Auto-ranging multi-function counter

**\$349**

1900A



- Traditional Fluke quality
- Autoranging in both frequency and period measurements
- 5 Hz to 80 MHz, high sensitivity — 25 mV
- Event counting to 10<sup>6</sup> events, automatic overflow
- Six digit LED display with automatic annunciation
- Optional binary operation and data output
- Full 12-month warranty
- Service centers coast to coast
- Available in stock

**FLL** **KE**  
**COUNTER** **VISION**

John Fluke Mfg. Co., Ltd.  
P.O. Box 1094, Station "D"  
Buffalo, N.Y. 14210  
Phone (716) 842-0311  
TWX 610-492-3214

More Details Circle (22) on Reply Card

## Oneida INSTANT-WELD<sup>®</sup> ADHESIVE

ALPHA CYANOACRYLATE

THE MOST ADVANCED FORMULAS FOR INDUSTRIAL AND PROFESSIONAL USE

- One component only—no mixing required.
- Versatile—bonds metal, glass, phenolics, rubber, ceramics and plastics.
- Extremely rapid setting—seconds, not hours.
- Economical—one drop covers one square inch and costs less than ¼¢.
- Very strong—up to 5000 lbs./in<sup>2</sup> tensile strength
- Fingertip pressure only—no clamps or fixtures
- Sets at room temperature—no heat needed
- Does not use solvents or catalysts.

SAVE UP TO 50% BY BUYING OUR BIG, ECONOMY BOTTLE, UP TO 1,900 "ONE DROP" APPLICATIONS. ORDER FROM YOUR ONEIDA DISTRIBUTOR OR DIRECT FROM US.



Ship \_\_\_\_\_ bottles @\$8.95 each. 759-D

Name \_\_\_\_\_

Company \_\_\_\_\_

Address \_\_\_\_\_

City \_\_\_\_\_ State \_\_\_\_\_ Zip \_\_\_\_\_

TERMS: Check with order - we pay postage.

**Oneida** **ONEIDA ELECTRONIC MFG. INC.**  
Meadville, Pa. 16335

For More Details Circle (23) on Reply Card

# catalogs literature

Circle appropriate number on Reader Service Card.

**101. Electronic Tool Company**—a catalog describing 18 fully-equipped tool kits has been published for technicians. Also featured are 13 tool cases that can be ordered custom-filled with a choice of tools, meters, parts containers, etc.

**102. Pomona Electronics**—introduces the Pomona line of electronic test accessories, and provides illustrations and complete engineering information including dimension drawings, schematics, specifications, features, and operating ranges in the 68-page catalog covering 500 products.

**103. Motorola Training Institute**—offers an 8-page pamphlet describing MTI's newly-revised home-study course. The pamphlet outlines the contents of 40 lessons and 13 reference texts included with the course, which covers professional FM two-way radio from the technician's point-of-view.

**104. Westinghouse**—"Color Picture Tube Interchangeability Guide" is divided conveniently into two sections. The first section includes charts for each size and heater version of 90° color tubes, 19V-25V. A simple coding system shows which types are interchangeable. The other section is an alphabetical listing of all the tube types shown in the charts. The guide also provides safety tips on tube-replacement procedures and a history of color picture-tube development.

**105. Switchcraft**—containing more than 4,000 product listings, the short-form catalog provides product data and prices of major Switchcraft product lines including telephone jacks, plugs, switches, connectors, molded cable assemblies, and audio accessories. A numerical-alphabetical index shows the page number, column, and line number location of every product in the catalog.

**106. Howard W. Sams & Co., Inc.**—an 88-page catalog features more than 400 popular hardbound and paperback books. Topics include electronics, amateur radio, audio and hi-fi, mathematics, Audel do-it-yourself books on appliances, mechanical power, sheet metal, and others.

**107. Littelfuse**—an all-in-one automotive fuse-replacement guide covers both domestic and foreign automobiles and lists the manufacturer, year and model, protected circuits and accessories, fuse, fuse description, and normal mounting and location of the fuseholder. □

## BELTRON® The Original TV Picture Tube Restorer



**"Don't Be Misled"**  
**Imitators can make all kinds of claims on paper**  
**"But"**

**Performance is what you want! Compare results before you buy.**

**Ask for a "in your shop" demonstration!**  
**Over "5" years proven experience to back up our performance claims.**

**NOW ONLY \$299<sup>00</sup>**

*Call your local distributor today or write*

**APPLEWAY ELECTRONICS**  
**P.O. Box 284 Parkwater Station**  
**Spokane, WA 99211**



U.S. Patent No. 3,641,391

**For news of our industry, read Electronic Scanner, page 4**

For More Details Circle (17) on Reply Card

Dear Editor:

Subject: Circuitry for Safety

Insurance companies state that high voltages found in color TV receivers are often the cause of fires claiming lives and property, when consumers fall asleep leaving the TV turned on.

I call on the manufacturers to install (or if necessary, the FCC to require to be installed) a simple circuit in TV receivers that would turn off the receiver's AC power when no signal from a TV station was received. Those stations transmitting all night could activate the power-off circuit by eliminating their carrier for five seconds every hour (or other predetermined time). This literally could be a life saver, in the early morning hours.

I am surprised this has not been done already. In the two decades I've been in the service business, I have worked with some fancy circuitry. Now, I'd like to see some simple circuitry for safety.

Best regards,

Jerry Recob

Kansas City, Missouri

Dear Editor:

This is an open letter in reply to Mr. Thomas P. Brutscher (page 7 of *Electronic Servicing* for December, 1974).

Our company, too, is an "authorized servicer" for all major brands, and we object to the attitude of Mr. Brutscher. No field representative we have ever met would write a letter reflecting so little research, and we are surprised that a major manufacturer would condone an open letter of this type.

We try to cooperate with all manufacturer's policies and procedures. But the truth is that a lot of these procedures are unfair to the independent servicer and to the customers.

Warranty should be for a shorter time period, such as 90 days. The manufacturers are saving money on the inboard warranty programs at the expense of the servicers, because of the low rates. Also, it is

wrong for a manufacturer to use the pretense that labor claims are used for quality control.

What's more, the servicer should not be denied labor payment just because the dealer did not register the set. The customer won't pay, and the servicer is stuck, when it wasn't his fault.

Sincerely,

Russell Sebring

Bradenton, Florida

(Continued from page 27)

## Solution to: OHM ON THE RANGE

- |                    |                |
|--------------------|----------------|
| 1. cannibalization | 13. automatic  |
| 2. monochromatic   | 14. radiation  |
| 3. bombardment     | 15. switching  |
| 4. breakdown       | 16. flycutter  |
| 5. servicing       | 17. hypersonic |
| 6. deviation       | 18. component  |
| 7. bilateral       | 19. duodiode   |
| 8. heelpiece       | 20. dosimeter  |
| 9. wavemeter       | 21. resonator  |
| 10. calibrate      | 22. manometer  |
| 11. broadband      | 23. bandwidth  |
| 12. permatron      | 24. conduit    |
|                    | 25. Invar      |

**Start with 100 points  
and deduct 4 points for  
any part you may not  
have answered correctly**

Your rating:

60 - 64 Oh no.

68 - 72 So-so.

76 - 84 Oh ho!

88 - 96 Yo ho ho!

**100 PERFECT!**

Give yourself a pat on the  
back; you deserve it!

**Your comments and  
ideas are welcome.**

# THE CURVE TRACER THAT WON'T COLLECT DUST.



The Hickok Model 440 semiconductor curve tracer is all purpose and convenient to use. It's the ideal instrument for testing, evaluating, classifying and matching all types of transistors, FET's and diodes. You'll get stable, full range dynamic displays that you can accurately scale right from the screen.

- Pull-out card for easy, fast set-up and operation.
- Set-up marks for rapid set-up of 80% of tests.
- Unique INSTA-BETA display takes the guesswork out of transistor and FET parameter measurement.
- In-or-out of circuit testing.
- A full range professional tracer at a price you can afford.

The Model 440 is the most modern, versatile tracer available. See it at your Hickok distributor or send for our technical bulletin.

**\$165<sup>00</sup>**

## HICKOK

**the value innovator**

INSTRUMENTATION & CONTROLS DIVISION  
THE HICKOK ELECTRICAL INSTRUMENT CO.  
10514 Dupont Avenue • Cleveland, Ohio 44108  
(216) 541-8060 • TWX: 810-421-8286

For More Details Circle (24) on Reply Card

## The MARKETPLACE

This classified section is available to electronic technicians and owners or managers of service shops who have for sale surplus supplies and equipment or who are seeking employment or recruiting employees.

**Advertising Rates**  
in the Classified  
Section are:

- 25 cents per word  
(minimum \$3.00)
- "Blind" ads \$2.00  
additional
- All letters capitalized  
35 cents per word

Each ad insertion must be accompanied by a check for the full cost of the ad.

Deadline for acceptance is 30 days prior to the date of the issue in which the ad is to be published.

This classified section is not open to the regular paid product advertising of manufacturers.

## FOR SALE

NEW Canadian Magazine "Electronics Workshop". \$5.00 yearly. Sample \$1.00. Ethko, Box 741, Montreal "A" Canada. 10-74-12t

UNUSUAL SURPLUS AND PARTS Catalog. \$1. ETCO Electronics Dept. E.S., Box 741, Montreal "A" H3C 2V2. 12-74-12t

LOW NOISE RESISTORS - 1/4W, 5%, carbon film from 10 - 3.3 Megohm for 3 1/2 cents. Fifty of one value for \$1.25. 1N4148 diodes for 6 cents. 75 cents postage. Free samples/specifications. Components Center-ES, Box 134, New York, N.Y. 10038 3-75-6t

HARD-TO-FIND TV & Radio Parts, New & Used. Ask Anyway. CMC 4329-4 Woodman, Sherman Oaks, Calif. 91423 3-75-6t

FOR SALE: 479 Sams Photofacts. Most are brand new. Number 902 thru 1381. \$700 buy all. Assorted older series \$1.50 each. Victor Herrick Co., Rt. 1, Box 492, Coos Bay, Ore. 97420.5-75-1t

FOR SALE - HEATH - Post Marker/sweep generator - (G57A) - Perfect, used one month. \$150.00. C. Porcari, 630 N. 65 Way, Hollywood, Fla. 33024. 5-75-1t

B & K 1077B Analyzer, half price \$227. Good condition. Box 71, Boston, Mass. 02199. 5-75-2t

ADVERTISING PACKAGE FOR TV service shops. Inexpensive eye catching ads contain personal message from you-build customer confidence. Keeps your name before the public weekly. PROVEN RESULTS. Thirty ads with instructions \$19.95. Sample \$1.00 refundable. TV TIPS, 430 South Jefferson, Lebanon, Mo. 65536. 5-75-4t

## EDUCATION-INSTRUCTION

REPAIR TV TUNERS—High Earnings: Complete Course Details, 12 Repair Tricks, Many Plans, Two Lessons, all for \$2. Refundable. Frank Bocek, Box 3236 Enterprise, Redding, Calif. 96001. 12-74-6t

PICTURE TUBE REBUILDING. Investigate and learn before you invest time and money. Qualified personnel to guide you. Write to: Engineered Electronic Services, 7127 Marshall Drive, Boulder, Colorado 80303. 4-75-2t

## BUSINESS OPPORTUNITY

TELEVISION BUSINESS SALES AND SERVICE. Exclusive Zenith and Magnavox Franchise, grossing over \$180,000.00 last year, concrete block building 25x100', 1,200 sq. ft. sales area, 450 sq. ft. repair shop and storage, 1,600 sq. ft. apartment, three bedrooms, two bathrooms, fireplace, carport and sundeck. Located in beautiful Central British Columbia, six miles from USA border. Ski, swim and fish. Down payment for stock and building \$45,000.00. For information write to Electronic Servicing, Dept. 505, 1014 Wyandotte, Kansas City, Mo. 64105. 4-75-2t

FOR SALE Established Television Sales and Service Business located in the growing Front Range area of Colorado. For further information write: S. Ellis, P.O. Box 1947, Evergreen, Colorado. 80439. 5-75-2t

WISH YOU COULD TAKE A VACATION OR A FEW DAYS OFF WITH YOUR BUSINESS SAFE? Even to return to discuss new directions and new solutions? Technician/manager/teacher is available within period June 3 to 10 or July 9 to 18. Write to: Mr. Harrie R. Buswell, Box 474, Boone, Iowa 50036. 5-75-1t

## advertisers' index

Appleyay Electronics .....	56
Arrow Fastener Co., Inc. ....	16
B & K Div., Dynascan Corp. ....	7
Bussman Mfg. Div., McGraw-Edison .....	Cover 3
Castle TV Tuner Service, Inc. ....	Cover 4
Charous & Niebergall. ....	49
Cleveland Institute of Electronics .....	51-52
Fluke Mfg. Co.-Counter Division. ....	55
Gem City Tuner Service. ....	13
General Electric Co., Receiving Tube Dept. ....	48
General Electric Co., TV Business Div. ....	11
Harnischfeger .....	58
Heath Company .....	45
Hickok Elect. Instruments Co. ....	12,57
Jensen Tools and Alloys .....	49
Lectrotech .....	47
Mallory Distributor Products .....	3
Oelrich Publications .....	49
Oneida Elect. Mfg. Inc. ....	55
Perma Power .....	23
Precision Tuner Service .....	Cover 2
Quasar Electronic Corp. ....	1
Quietrole Company .....	49
RCA Electronic Components .....	41
Rohn Manufacturing .....	9
Sperry Tech, Inc. ....	10
GTE Sylvania- ECG Consumer Renewal .....	17-18
Tuner Service Corporation .....	5

### MOVE UP INTO INDUSTRIAL ELECTRONICS ELECTRONIC SERVICE TECHNICIANS FOR SPECIALIZED FIELD SERVICE ON ELECTRIC MINING SHOVELS

We are the world's leading manufacturer of electronically controlled mining shovels. Our fast rate of expansion has provided opportunities for continuous growth.

If you have experience and/or schooling in Industrial Electronics, we would like to hear from you.

Successful applicants will be trained by us. Assignments may include world-wide travel.

We offer excellent compensation commensurate with experience and liberal fringe benefits.

Send your resume to:

Mr. Kevin Dugan, Personnel Dept. C-3  
HARNISCHFEGER CORPORATION  
P.O. Box 554, Milwaukee, Wisc. 53201

# Harnischfeger

# P&H

An Equal  
Opportunity  
Employer M/F

# For the Protection of ALL ELECTRONIC CIRCUITS

## FUSETRON® dual-element — time-delay fuses



Avoid nuisance opening, yet get full short-circuit protection. Available from 1/100 amp. to 40. Size 1/4 x 1 1/4 in. and 9/32 x 1 1/4 in.

## TRON® rectifier fuses

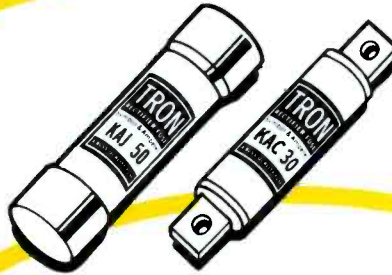

Provide extremely fast opening and high degree of restriction of let-thru current to protect Solid State Devices. Ampere rating 1/2 to 1000 in voltages up to 1500.

## BUSS GLASS TUBE FUSES "quick-acting"

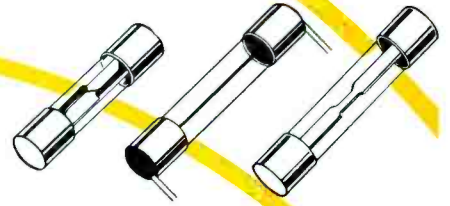

Provide high speed action to protect delicate instruments and apparatus. Available from 1/500 to 30 amp. Size 1/4 x 1 in. and 1/4 x 1 1/4 in.

## BUSS Signal-Indicating Alarm-Activating FUSES



Available with time-delay or quick-acting characteristics. Available from 1/10 to 30 amp. Size 1/4 x 1 1/4 in. and 13/32 x 1 1/2 in.

## TRON® Sub-Miniature Pigtail Fuses

Size only .145 x .300 in. Glass tube permits visual inspection. Hermetically sealed. Available from 1/200 to 15 amp.



## BUSS Fuses for TELEPHONE COMMUNICATIONS Similar equipment

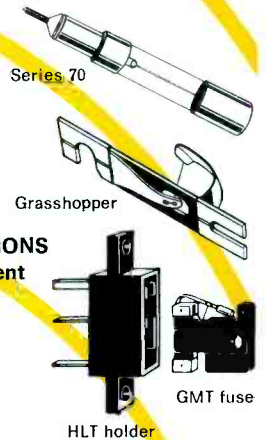

HLT holder

## BUSS SNAP-LOCK FUSEHOLDER

Rear panel mount fuseholder for 1/4 x 1 1/4 in. fuses. Snaps into place. Specify HTA-00 for space saver type, HLD-00 to take visual indicating fuses. HKP-00 for standard fuseholder. HJM-00 to take 1/4 x 1 in. fuses.



HKP panel mounted fuseholder for 1/4 x 1 1/4 in. fuses.



HKA lamp indicating, signal-activating fuseholder.



## BUSS Sub-Miniature GMW fuse

and HWA fuseholder. Full size .270 x .250 in. with window to check fuse element. Available 1/200 to 5 amp.



## BLOCKS FOR BUSS FUSES

All types available for every application. Single pole, multiple pole, small base, laminated base, porcelain base for fuses from 1/4 x 5/8 in. up. Also signal fuse blocks and special blocks of all types.

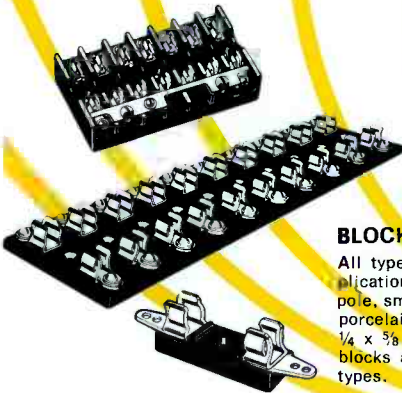

# BUSS® FUSES

## For Quality — Reliability

For anything you need in protecting electronic circuits and devices —

Write for Bulletin SFB

— See for yourself —



BUSSMANN MANUFACTURING  
a McGraw-Edison Company Division  
St. Louis, Missouri 63107



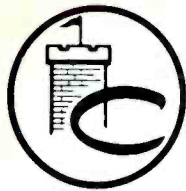

# CASTLE TV Service Instruments

## ...Timesavers for the Professional

### **MASTER SUBBER®** TV signal circuit analyst

Analyze the ENTIRE signal circuit system of any Color or Black & White Television receiver . . . by signal substitution.

Outputs at video i.f., sound i.f., video and audio.

- Inbuilt monopole antenna ● Inbuilt loudspeaker ● Video carrier level meter ● Battery indicator meter

Use on the bench or in the home . . . anywhere.

Complete with batteries, 120vac wall plug-in transformer and matched test cables.

**MASTER SUBBER® Analyst Mk V net \$169.95**



### **SUBBER®** TV Tuner analyzing instrument

Analyze the tuners, i.f. amplifier system and agc system of Color or Black & White Television receivers . . . by signal substitution.

Use on the bench or in the home . . . anywhere.

Complete with batteries and matched test cables.

#### **TV TUNER SUBBER® Analyst**

**Mk IV (Battery model) net \$45.95**

**Mk IV-B (120 VAC + Battery model) net \$52.95**



### **MEZZER™** VHF Field Strength Meter

Use for measurements of VHF TV signals in:—

- Antenna installation ● MATV
- Antenna evaluation ● CATV
- Output calibration of TV signal generators.

Range: 20 microvolts to 100 millivolts.

Attenuator: x 1, x 10, x 100. Inputs: 75 ohms & 300 ohms.

Uses two 9v Alkaline batteries for field use, comes complete with 120vac wall plug-in transformer.

**Model FSM-V net \$119.95**

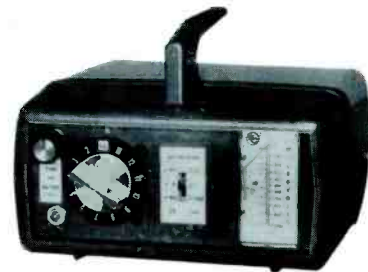

### **MEZZER™** UHF Field Strength Meter

Use for measurements of UHF TV signals in:—

- Antenna installation ● MATV
- Antenna evaluation ● CATV
- Output calibration of TV signal generators.

Range: 20 microvolts to 10 millivolts.

Attenuator: x 1 and x 10. Inputs: 75 ohms & 300 ohms.

Uses two 9v Alkaline batteries for field use, comes complete with 120vac wall plug-in transformer.

**Model FSM-U net \$99.95**



These instruments boast the extra features of all Castle products-advanced technology-modern styling-and they work!

Ask your electronic distributor for them . . . or write for more details.



## CASTLE TV TUNER SERVICE, INC.

5701 N. Western Ave., Chicago, Ill. 60645 • Ph. 312-561-6354

In Canada: Len Finkler Ltd., Ontario

For More Details Circle (2) on Reply Card